

# WATERFORD WASTEWATER TREATMENT PLANT EPA WASTE LICENCE APPLICATION

## NON-TECHNICAL SUMMARY

---

Technical Report Prepared For

**Environmental Protection Agency**

---

Technical Report Prepared By

**Mairead Morrissey** Senior Environmental Consultant

---

Our Reference

MM/08/4084A.1Rev.3

---

Date of Issue

2<sup>nd</sup> May 2008

---

For inspection purposes only.  
Consent of copyright owner required for any other use.

### Dublin Office

The Tecpro Building,  
Clonshaugh Business & Technology Park,  
Dublin 17, Ireland.  
T: + 353 1 847 4220  
F: + 353 1 847 4257

AWN Consulting Limited  
Registered in Ireland No. 319812  
Directors: F Callaghan, C Dilworth,  
T Donnelly, E Porter  
Associate Director: D Kelly

For inspection purposes only.  
Consent of copyright owner required for any other use.

**Report Prepared By:**

**Report Checked By:**



**MAIREAD MORRISSEY**  
Senior Environmental Consultant



**DR FERGAL CALLAGHAN**  
Director

## 1.0 INTRODUCTION

Waterford City Council (WCC) is applying to the Environmental Protection Agency (EPA) for a Waste Licence for the operation of the sludge treatment works that is part of the Wastewater Treatment Plant (WWTP) at Gorteens, Co. Kilkenny (See Figures A.1.1 and A.1.2).

This Non-Technical Summary is included as Attachment A.1 of the application to the EPA (herein referred to as the Agency) and summarises the sections of the application form and associated attachments.

## 2.0 GENERAL INFORMATION

### 2.1 Planning Permissions & EIS

The WWTP was granted permission in January 2000 by An Bord Pleanála. The An Bord Pleanála Planning Reference is PL 10.111331 and a copy of this permission is included with the Waste Licence application.

An Environmental Impact Statement (issued in November 1998) was submitted with the planning application for the WWTP.

A report (Ref. MM/07/4084R01), updating the relevant sections of the EIS has been prepared by AWN Consulting Ltd and included as part of this application.

### 2.2 Site Notice and Notification of Application Intent

A Site Notice advising of the Waste Licence application has been erected at the entrance road to the WWTP, i.e. the current entrance at the last point the public have access. The notice will remain in place for one month after the date of submission to the EPA.

Notification of the Waste Licence application was also placed in the following newspaper publications: Munster Express (dated 9<sup>th</sup> May, 2008) and the News and Star (dated 9<sup>th</sup> May, 2008).

Written notification was provided to Kilkenny County Council, as the relevant Local Authority, in April (by AWN Consulting) & May (by Waterford City Council) 2008.

### 2.3 Activities to be Licensed

The licensable activity is the treatment of the sludge that is generated from the sewage that is treated at the facility. The principal and other activities (under Schedules 3 and 4 of the Waste Management Acts 1996 – 2003) are as follows:

The Principal Activity, under Schedule 3 No. 6 of the Waste Management Acts, is disposal:

*No.6. Biological treatment not referred to elsewhere in this Schedule which results in final compounds or mixtures which are disposed of by means of any activity referred to in paragraphs 1 to 5 or paragraphs 7 to 10 of this Schedule.*

The facility will produce sludge bio-cake as a waste product during the wastewater treatment process. This sludge will be collected on site in trailers/containers before

being transported off-site. Under this activity class, the sludge may be disposed of to an EPA licensed landfill.

The Secondary Activity, under Schedule 4 No. 2 of the Waste Management Acts, is recovery:

*No. 2. Recycling or reclamation of organic substances which are not used as solvents (including composting and other biological processes)*

It is proposed that dewatered 'class A' bio-cake will be recycled to off-site agricultural land by means of land-spreading, with full compliance with the Code of Good Practice regulating such activity. It is envisaged that over time, the majority of the sludge will be recovered by landspreading on agricultural land.

### **Summary of Maximum Tonnage**

The maximum annual tonnage to be treated at the site is measured as the amount of primary sludge generated by the picket fence thickener, plus the surplus (activated) sludge, which has passed through the gravity belt thickeners, over the lifetime of the site.

Maximum annual tonnage is expected to be 250.5 tonnes/day or 95,100 tonnes/year. The maximum load year is expected to be reached by 2025.

The calculations are based on the assumption that the plant will run 365 days per year and assumes full load plus 20%, as required by the Contract Specification for the facility.

## **2.4 Seveso II Regulations**

Based on information available for products used on site and corresponding usage and storage volumes, the EC (Control of Major Accident Hazards involving Dangerous Substances) Regulations 2006 (S.I. No. 74 of 2006) do not apply to the site.

## **3.0 DESCRIPTION OF SITE AND ACTIVITIES**

### **3.1 Description of Facility**

As part of the Waterford Main Drainage Scheme, an urban WWTP and outfall pipeline will operate on an 18 hectare portion of land located at Springfield House, Gorteens, Co. Kilkenny. The facility will provide Waterford City and its Environs with appropriate primary and secondary treatment for a population equivalent of 189,000.

A plan drawing of the site is provided (Figure A.3.1), showing the location of all wastewater treatment activities and identifying all buildings and facilities.

### **3.2 Hours of Operation**

The facility will be in operation 365 days per year, 24 hours per day. However, all processes will not be in operation continuously. Normal operating hours are Monday – Friday, 08:00 – 20:00 and Saturday 08:00 – 16:00.

### **3.3 Outline Environmental Management System (EMS)**

An EMS will be put in place at the Waterford WWTP (WWTP) in order to manage and control the possible environmental impacts of the facility.

The WWTP EMS will incorporate procedures for pro-active management of environmental issues and liabilities. The EMS will be implemented when the facility becomes operational.

The EMS is structured as follows:

- Environmental Policy
- Schedule of Aspects and Impacts
- Aspects
- Impacts
- Legal Register
- Schedule of Objectives and Targets

Provisional Objectives are as follows:

1. To reduce energy consumption
2. To minimise the use of natural resources
3. To examine alternative waste recovery options for sludge cake from the facility

Specific Targets for each operational year will be confirmed and included in the EMS. There will be specific roles and responsibilities established within the facility to manage, control and operate the EMS.

Standard Operating Procedures will be put in place. These are procedures that will be followed to ensure legal environmental compliance, to prevent and mitigate environmental pollution on site and to allow the environmental targets for the facility to be achieved e.g. energy-use reduction targets, waste recycling targets, etc.

Training will be provided for employees and management at the facility in order to ensure the EMS is implemented and maintained correctly.

An environmental records system will be maintained as part of the EMS. These records will include data on energy consumption, natural resource and raw material use, waste generation, waste disposal and waste recovery/recycling and emissions from the facility (odour, air quality, noise & vibration etc)

There will be procedures to follow for the purpose of conducting an internal environmental audit.

### **3.4 Structure and Personnel**

The facility will be run on behalf of WCC by CAW. The structure of management and staff is detailed below.

The Operations Director (CAW) will have overall responsibility for the running of the WWTP.

Responsibilities of the Operations Director are: Client liaison, contract compliance, providing environmental & safety framework for delivering O&M (Operations and Maintenance) services to Waterford City Council (WCC).

The Operations and Maintenance Manager (CAW) will control the daily running of the facility.

Responsibilities of the Operations and Maintenance Manager are: Report to the Operations Director. Day to day management of the operations contract with WCC. Coach the local operations team in the delivery of their duties. Ensure training is provided and competence is maintained. Provide technical, financial and administrative support. Ensure O&M procedures are in place to ISO 9001, 14001, 18001. Supervise operational staff, craftsmen & subcontractors, to ensure that treatment standards are met, planned plant maintenance is delivered, and breakdowns are promptly fixed. Buy spares parts & contracted services as required.

The operations manager will report to Waterford City Council monthly. Respond to any complaints promptly. Action any remedies to keep plant compliant with effluent, sludge & odour standards.

The Works Technicians will include operators & fitters that will be trained to CAWs in-house Production Qualification standards.

Responsibilities of the Works Technicians are: Report to the O&M Manager. The technicians will undertake the day to day work of cleaning, optimizing, maintaining and monitoring the plant. Daily samples will be analysed to check plant performance. Records and logs kept of maintenance undertaken. Respond on standby to out of hours alarms from telemetry.

### 3.5 Site Infrastructure

#### Site Security Arrangements

A permanent security fence runs around the perimeter of the site, with the exception of the eastern section of the site, where it is inside of the existing trees on the site and also to the south, where the fence is inland of the site boundary. This is to accommodate the proximity to the estuary.

The entrance gates from the access road to the facility are located at the northeast corner of the site, at Grid Ref. S6500 1244. The site will be manned 24 hours a day, 7 days a week, i.e. when the site personnel are not on site, there will be site security present.

#### Design for Site Roads

Treatment plant roads have been designed to accommodate all vehicles proposed for the operation of the WWTP in accordance with the planning permission for the facility. Roads have been designed in accordance with NRA guidance 'Design Manual for Road and Bridge Works' and based on the ground conditions at the site and the traffic loading for the operational phase of the facility.

#### Design of Hardstanding Areas

The hardstanding area is comprised of the area that will drain to swales and an area that will drain directly to a trunk sewer.

#### Plant

This includes the plant items for the following processes/areas:

- Preliminary treatment (screening and grit Removal)
- Primary treatment (primary settlement tanks)
- Secondary biological treatment (conventional activated sludge)
- Final clarification
- Primary sludge thickening (gravity consolidation tanks)
- Secondary sludge thickening

- Sludge treatment (pasteurisation and anaerobic digestion)
- Sludge storage
- Sludge dewatering
- Biogas utilisation and storage

### **Laboratory Facilities**

There will be no laboratory facilities on site. The Nominated Laboratory required for the WWTP will be advised by the Operator prior to commissioning of the facility but will not be on the site. Provision may be made on the site for 'local' testing facilities and if this occurs, details will be provided to the Agency.

### **Design and Location of Fuel Storage Areas**

Fuel, which is diesel, stored on site will be for the generator and the boilers. The fuel storage tanks are located beside the Sludge Thickening, Dewatering and Digestion Control Building. The tanks are located within a containment bund, constructed to BS 8007 or CIRIA 163, which will provide a second layer of protection. This bund is designed to hold 20,000 litres, plus 25%, which will allow for rainwater ingress and ensure that no fuel is released to the ground or water.

### **Traffic Control**

Traffic on site will be via a one-way system, with trucks and other vehicles entering the site at the northeast corner, and travelling in a clockwise direction around the site.

Traffic to the site, once constructed, is limited to plant personnel and visitors and also traffic associated with the operation of the plant. The administration building is located to the north of the facility and all visitors are required to park in the parking area adjacent to the building and report to reception.

### **Sewerage and Surface Water Drainage Infrastructure**

#### Surface Water Runoff

There are SUDS (Sustainable Urban Drainage Systems) included in the design of the surface water drainage system. The road runoff will be collected via a system of swales and gullies draining to a trunk surface water pipe. This then discharges to an existing stream at the southeast corner of the treatment works site, which discharges into the Suir Estuary.

The trunk sewer will convey water from the swales and from the remaining impermeable areas within the site.

A hydrocarbon interceptor will be installed upstream of the surface water outfall to prevent any risk of hydrocarbon pollutants entering the receiving water.

Surface Water runoff from the area within the bunded area, i.e. the immediate area surrounding the treatment works, will be directed into the wastewater treatment works to the return liquors area. This will be returned to the top of the wastewater treatment works and re-enter the treatment system.

#### Foul water Drainage

Foul water will be produced from the toilets within the sludge building and from the administration building. This wastewater will be directed to the wastewater works via the return liquors area. Foul water from the administration building runs by gravity into Bellview Pumping station, which is located to the east of the admin building in the northeast corner of the site, where it becomes part of the main Bellview Pumping Station flow into the inlet works.

### 3.6 Facility Operation

#### Start-Up Period

It should be noted that there will be an intermediate period for the start-up of the WWTP. This will occur when discharge from the existing outfalls (that discharge into the Suir or tributaries of the Suir) is terminated and the discharge is re-directed through the new outfall (SW-02 for the purpose of this application) for the WWTP.

During this period, there may be little to no treatment of the wastewater as the plant is commissioned. This period will last no longer than 3-4 months and will constitute no change in the wastewater that is currently being discharged into the Suir River/Estuary, other than changing the discharge point. It will be a very short period before the wastewater undergoes increased levels of treatment and almost immediately the quality of the discharge will begin to improve.

Figure A.3.2 shows the existing outfalls and the new WWTP outfall. It can be seen from this diagram that there are a number of existing outfalls in close proximity to the new WWTP outfall; these are located at Maypark, Slievruie and two in the vicinity of King's Channel.

#### Overview of Processes at the WWTP

The overall process at the WWTP facility is outlined below. However, it should be noted that, for the purpose of this Waste Licence application, it is only the sludge treatment works, i.e. when the primary sludge leaves the Picket Fence Thickener (PFT) and is combined with the activated sludge in the sludge blending tank, which is considered to be the licenceable activity.

Flow (sewage) arrives (via a system of pumped and gravity sewers) at the main Works inlet building. Sewage is screened and the sewage passes to a distribution chamber and into two primary settlement tanks (PSTs). During storm conditions excess flow, passes to the two storm tanks. When low flows are detected coming into the works, any storm water within the storm tanks is returned to the inlet works.

The settled wastewater then flows to the secondary treatment process that comprises a selector tank and Inclined Bubble Aeration (IBA) process. The activated sludge flocs (surplus sludge) are separated from the mixed liquor. The settled effluent passes to the final effluent (FE) Sampling and Washwater Pumping Station prior to passing to outfall.

The Activated Sludge is returned to the Selector Tank for mixing with the settled primary sewage, prior to introduction into the aeration tanks, thereby providing the continuous biological activated sludge process culture within the Works.

Primary sludge is thickened in a picket fence thickener before it is transferred to the sludge blending tank. Activated sludge is also thickened by gravity belt thickener before it is transferred to the sludge blending tank. The blended sludge is pumped to the pasteurisation system, which feeds into the anaerobic digesters.

Biogas generated within the digester is stored in a gas holder and is utilised to provide fuel to the boilers to heat the raw sludge. The displaced digested sludge flows to a digested sludge holding tank. From here the digested sludge is pumped to one of two sludge dewatering belt press streams to produce a cake of minimum 23% dry solids. Dewatered cake is loaded into trailers/containers prior to being removed from site.



Areas of the WWTP are odour-controlled. Odours from the Works Inlet building and PSTs are directed to one odour-handling unit and extractions from the Sludge Building and the sludge tanks to a second odour handling unit.

Flow diagrams of the overall processes are shown in Figures A.3.3 and A.3.4 and flow diagrams of the sludge treatment processes are shown in Figures A.3.5 and A.3.6.

There is the potential for future ultra-violet light (U.V.) treatment for the treated effluent at the facility, which will provide disinfection, killing micro-organisms.

## **Overview of Management & Maintenance Plans**

### General

The management of the facility will develop and implement the following procedures and information systems required for the operation and maintenance works. These include the following:

- Standard and Emergency Procedures
- Quality Assurance Management System
- Environmental Management Procedures

The systems will include activity planning and performance monitoring, maintenance of programme and targets, and management of reports and procurement procedures.

The operation of the facility will be measured by a Performance Management System (PMS). The performance of the facility will be monitored on a daily basis. Monthly status reports will be submitted to the plant manager.

Standard procedures will be in place for the operation and maintenance of the facility. Internal compliance audits will be carried out at least annually, but may be increased if required.

### Maintenance

For the maintenance of the facility, a Facility Management Plan will be prepared prior to operation of the facility (which will be, in part, based on the commissioning phase). The Plan will set out requirements for the management of the WWTP, including:

- Buildings and site surrounds
- Landscaping
- Plant and Materials

## **Emission Sources**

### Odour Emissions

There will be odour emissions from the WWTP. Odours will be generated in the Works Inlet building and the Sludge Building (and associated tanks) and passed to 2 no. odour-control units (OCUs), which will mitigate the odours from these areas. Therefore, there are two odour emission points.

Odour emission points are as follows:

- |        |  |
|--------|--|
| OCU-01 | OCU 1 - Works Inlet Building                   |
| OCU-02 | OCU 2 - Sludge Building (and associated tanks) |

### Air Emissions (Other than Odour)

There will be emissions to air from the hot water boilers, fed by the biogas from the anaerobic digestion process (or by diesel when biogas is not available) and also from

the waste gas burner, which will burn off excess biogas. The waste gas burner is not considered to be an emission point and is included as a minor emission.

Air emission points are as follows:

A-01(a&b) Hot Water Boilers (Pasteurisation Process)

#### Noise

It is not expected that noise emissions will be an issue for the site. It is expected that the noise levels will be within the specification limits. The noise emission sources are shown in Section 5 of the NTS.

#### Ground/Groundwater

There will be no emissions to ground or groundwater, with the exception of surface water drainage percolating into the ground through the 2 no. swales in the northern part of the site.

In the event of a malfunction or interruption of services, the emergency procedures will be implemented.

## **4.0 EXISTING ENVIRONMENT**

### **4.1 Air Quality & Odour**

#### **Air Quality**

The assessment of air quality (excluding odour) has been carried out using a phased approach as recommended by the UK DEFRA. In the current assessment, an initial scoping of possible key pollutants was carried out.

An assessment of the baseline air quality in the region of the proposed development has been carried out by reference to suitable EPA long-term monitoring data. Air quality monitoring programs have been undertaken in recent years by the EPA and Local Authorities. The most recent annual report on air quality entitled "Air Quality Monitoring Annual Report 2006" (EPA, 2007), details the range and scope of monitoring undertaken throughout Ireland.

The assessment showed that existing baseline levels of NO<sub>2</sub>, SO<sub>2</sub>, CO, benzene, PM<sub>10</sub> and PM<sub>2.5</sub> are below ambient air quality limit values in the vicinity of the proposed development.

A baseline odour survey was carried out by Bord na Mona in April 2007 at the site and surrounding area. Hydrogen sulphide and meteorological measurements were made over a two day period in the vicinity of the WWTP site and also at selected sensitive receptors. Monitoring was carried out at over 75 locations on each day.

The Bord na Mona report determined that the levels measured during the survey were comparable to previous ambient background concentrations measured during sampling programmes carried out in Wales in 2003 and 2004.

### **4.2 Surface Water**

There is a stream located to the west of the site, which enters the Suir Estuary south of the subject site. The stream takes field drainage from surrounding land and discharges into the Suir Estuary, which is the main hydrological body in the vicinity of the subject site, at the southeast corner of the site. No flow readings or monitoring data were available for the stream at the time of writing this report.

The main receiving water in the vicinity of the site is the Suir Estuary, which flows in an east to west direction close to the southern boundary of the site.

The Suir Estuary falls under the district area known as the Southeast River Basin District (SERBD). These districts have been put in place as part of the Water Framework Directive and through the SERBD project, water quality monitoring is carried out for the River Suir, as shown in Table 4.2.1. EPA water quality monitoring data is shown in Table 4.2.2 for the period 1993 - 1995.

**Table 4.2.1 SERBD Water Quality Monitoring Data for Suir River & Estuary 2005-2007**

Station No.	Location	DO	BOD	pH	Ammonia	Ortho-Phosphate	Nitrate	Total Coliforms	Faecal Coliforms
		% Sat	mg/l O <sub>2</sub>	pH Units	mg/l N	mg/l P	mg/l N	Count	Count
		Surface						/100ml	/100ml
50	R. Suir at Waterford Br.	88.87	2.04	8.04	0.17	0.03	2.34	16895	2629
51.2	R. Suir at Abbeylands	90.20	1.55	7.98	0.19	0.03	2.24	18389	4552
53	Waterford Castle	83.47	1.82	7.98	0.22	0.03	1.44	9183	859
58	R. Suir at King's Channel	84.25	1.87	7.98	0.22	0.03	1.23	8317	1237
59	R. Suir at Belview Port	95.25	1.88	8.05	0.19	0.04	2.30	17618	1597
61	Estuary - Cheekpoint	92.24	2.05	8.07	0.15	0.03	1.54	6449	581

**Table 4.2.2 EPA Water Quality Monitoring Data for Suir River & Estuary 1993-1995**

Sampling Location	DO	BOD	pH	Ammonia	Ortho-Phosphate	Nitrate	Total Coliform	Faecal Coliform
	% Sat	mg/l O <sub>2</sub>	pH Units	mg/l N	mg/l P	mg/l N	Count	Count
	Surface						/100ml	/100ml
Giles Quay	89.17	1.4	8.12	0.08	0.05	-	16850	22983
Little Island	91.5	1.35	8.13	0.006	0.04	-	-	-
King's Channel	91.83	1.15	8.15	0.06	0.04	-	-	-

This data, along with data provided by a WCC water quality monitoring programme, indicates that the water quality for the Suir Estuary has deteriorated slightly over a period of 10-15 years.

The deterioration in water quality in the Suir Estuary is likely to be at least partially as a result of this increase of untreated wastewater discharge. There are currently 19 discharge points, as shown in Figure A.3.2.

#### 4.3 Groundwater

The underlying geology of the site is comprised of shales and siltstones, which can be highly weathered in the upper layers and quite weak. The depth to bedrock ranges significantly in the area, ranging from 3.8 m BGL (Below Ground Level) to

16.6 m BGL in the vicinity of the site. Direction of groundwater flow appears to be from north to south, i.e. towards the River Suir.

The bedrock aquifer has been given a Groundwater Protection Zone classification by the GSI (as part of the Groundwater Protection Scheme for Co. Kilkenny) of Rf/M – Regionally Important of Moderate Vulnerability.

Well card data from the GSI Well Card Database (a record of wells drilled in Ireland) shows a number of wells within a 3 km radius of the WWTP site. From these records, the underlying bedrock in the area has been shown to be capable of yields ranging from moderate (40 – 100 m<sup>3</sup>/day) to excellent (>400 m<sup>3</sup>/day).

The IDA Park, located directly to north of the site, is currently installing a borehole within the IDA Park for the purposes of water supply for the area until a public water supply is put in place by the Local Authority. It is understood that the IDA has permission to abstract approximately 10,100 gallons per hour (GPH).

#### 4.4 Noise

The existing environment in terms of background noise levels in the area were assessed. Noise measurements were conducted over the period: 13<sup>th</sup> – 14<sup>th</sup> March 2007 by Bord Na Mona (Environmental). Twelve measurement locations were selected, five at nearby noise-sensitive receptors and seven in the vicinity of the site boundaries. These are shown in Tables 4.1 and 4.2.

**Table 4.1** Noise Monitoring Locations at Nearby Sensitive Receptors

Ref.	Description
NM-01	Residential Area to west of site
NM-02	Residence at top of road leading to Prospect House, 200m from northwest corner of site
NM-03	Residential Area to northeast, approx. 750m from northeast corner of site boundary
NM-04	Residential Area to northeast, approx. 500m from northeast corner of site boundary
NM-05	Nearest residence to northeast, approx. 250m from northeast corner of site boundary

**Table 4.2** Noise Monitoring Locations at Site Boundaries

Ref.	Description
NM-06	Northwest corner
NM-07	Midway along northern site boundary
NM-08	Northeast corner
NM-09	Adjacent to the eastern boundary stream, approx 250m from the northeast corner of the proposed site boundary
NM-10	Midway along eastern site boundary
NM-11	Centre of site
NM-12	Midway along western site boundary

Ambient levels were shown to be representative of distant road traffic and activity at Belview Port during both the daytime and night-time surveys, with birdsong noted during daytime also.

#### 4.5 Flora & Fauna

A qualitative baseline study of the WWTP site was carried out on the 3<sup>rd</sup> March 2008. The previous surveys were carried out by the Aquatic Services Unit in June 1998. The 2008 surveys examined areas remaining around the construction area and compared it to descriptions made in the 1998 Report.

The 1998 Report summarised in the EIS acknowledges the proposed Natural Heritage Areas near Island View and Belmont House covering salt marsh adjacent to the site. However these sites have been superseded by the designation of the entire channel of the River Suir as the Lower River Suir candidate Special Area of Conservation (cSAC) under the Habitats Directive (designated in 2005).

The permitted development site overlaps with the cSAC boundary as the boundary extends into the salt marsh and runs parallel to the shoreline.

Other sites designated under the Habitats and Birds Directives within 5km of the site include the River Barrow and Nore cSAC that joins the Suir less than 5km downstream. The King's Channel, less than 3km upstream to the south west is a proposed Natural Heritage Area under the Wildlife Act 1976 as amended in 2000.

#### 5.0 ENVIRONMENTAL EMISSIONS AND IMPACTS

There will be a number of emissions from the WWTP. Emission points are shown in Figures A.5.1 – A.5.3.

##### 5.1 Emissions to Atmosphere & Impacts

The emissions to atmosphere will be:

- Odour
- Emissions from the boilers for the pasteurization process (that utilizes biogas from the anaerobic digestion process)
- Emissions from the waste burner (that burns off excess biogas from the anaerobic digestion process)

##### Odour

The most odorous processes across the plant are generated within the inlet works and primary tanks and the sludge building. The odour emission points are as follows:

- |       |  |
|-------|--|
| OCU-1 | Odour Control Unit No. 1, for the Inlet Works and Primary Settlement Tanks |
| OCU-2 | Odour Control Unit No. 2, for the Sludge Building                          |

A number of minor sources of odour were also noted, however these are not considered to be significant odour emission points and have not been assigned emission point references.

The foul air from each of the odour emission points is directed to an odour control unit (OCU). An odour dispersion model has been generated to show the predicted

resulting odour levels at receptors close to the site. The odour model has also taken into consideration the minor odour generators on the site.

There are not expected to be any fugitive emissions during normal operating conditions.

Based on information provided by Enpure, it is understood that the odour control units will ensure that the odour emissions from the WWTP will be within acceptable limits at the nearest sensitive receptors to the facility.

### Air Emissions

The air emissions, which will be minor, will be from the boilers that heat the water for the pasteurization process. These boilers (2 no.) will utilize the biogas that is generated during the anaerobic digestion process. The biogas will be stored in a tank and used as required for the boilers.

The excess biogas that is surplus to requirements will be burned off using an on-site gas burner.

The air emission point are as follows:

A-01(a&b) Boilers for Pasteurisation Process

The emissions to air will be nitrous oxides (NO<sub>x</sub>) and Carbon Dioxide (CO). Only during periods when the electricity supply is interrupted will diesel fuel be used to run the plant. In the event that this occurs, sulphur oxides (SO<sub>x</sub>) will be emitted to atmosphere also.

## **5.2 Emissions to Surface Water**

### Surface Water Runoff (Stormwater)

The emissions to surface water will be from the surface water runoff, from impermeable parts of the site (external to the sludge treatment section of the works) and the final treated effluent that will be discharged from the site to the Suir Estuary.

Surface water runoff will be from all impermeable areas of the site. The hardstanding runoff will be collected via a system of swales and gullies draining to a trunk surface water pipe. This then discharges to an existing stream, which runs along the eastern boundary of the site. The discharge (Emission) point is located at the southeast corner of the WWTP site and is as follows:

SW-01 Surface Water Runoff

A suitably sized Class 1 bypass interceptor will be installed upstream of the outfall to prevent any risk of hydrocarbon pollutants entering the receiving water.

Surface Water runoff areas within the bunded area, i.e. the immediate area surrounding the sludge treatment works, will be directed into the wastewater treatment works to the return liquors area and not discharged to the surface water collection system. This surface water will be returned to the top of the wastewater treatment works via return liquors and re-enter the treatment system.

### Final Treated Effluent

The final treated effluent (FTE) will be discharged through an outfall to the Suir Estuary, downstream of the WWTP. The emission point is as follows:

## SW-02 Final Treated Effluent Discharge

The FTE will be undergo primary and secondary treatment and the quality of the FTE will be to a standard specified by the operating contract terms. These parameter limits are specified in Table 5.2.

**Table 5.2 FTE Standards**

Parameter	Unit	Standard		Compliance Criteria	
		Target A	Target B	Target A	Target B
BOD	mg/l	25	50	No more than 3 daily samples per 60 days with a value for any one parameter or all parameters to be greater than the standards	No samples with a value for any one parameter to be greater than the standard
COD	mg/l	125	250		
Suspended Solids	mg/l	35	87.5		

The hydrological modelling, included as Appendix A of the original EIS for the facility, indicates that the operation of the Waterford WWTP will result in a significant increase in water quality status on a local and regional scale. This will be as a result of the primary and secondary treatment of all untreated wastewater (once the facility is operational), which currently discharges into the River Suir through the identified outfalls/pipes.

The monitoring requirements for the final treated effluent discharge from the Waterford WWTP will ensure that the quality of the discharge from the outfall pipe will be maintained to the required standard, and that there will be a positive long term impact on the surface water environment.

During the initial start-up period (3-4 months) the existing wastewater discharges will gradually be re-directed to the new outfall from the WWTP. There will be no change in the volume or quality of the discharge at the start of this period, and gradually the effluent quality will improve as the WWTP processes are commissioned and come online.

### 5.3 Emissions to Sewer

There will be no emissions to sewer, i.e. a sewer outside the scope and design of the WWTP. Therefore there are no emission points to sewer.

### 5.4 Emissions to Ground and Groundwater

The only emissions to ground waters will be from the surface water runoff from the roads, which will be directed into swales on the site that run along the northern section of the site, where the surface water will percolate into the ground. Therefore these are not point source emissions.

The swales are a SUDS (Sustainable Urban Drainage Systems) component and are grassed depressions for surface water drainage. The underlying soil is sandy clay with sandy gravelly clay in places. The underlying geology of the site is comprised of shales and siltstones.

Therefore, there is potential for percolation into the soil environment. However the impact of this is expected to be imperceptible.

## 5.5 Noise Emissions

A variety of mechanical plant items including pumps, fans, motors and compressors will be required to operate the site, which almost all have the potential to generate noise to some degree. Many of these are located outdoors on the site, however some are contained within buildings, which itself reduces the noise emission from these items.

The sound pressure levels for all significant items have been derived from manufacturers' data or from empirical formulae based on the electrical power rating for the item. These data were incorporated into a computer-based noise model used to predict the noise levels at nearby noise-sensitive locations.

Noise sources are as follows:

- Belview Pump (Pumping Station)
- Girt Grease Blower
- Stormwater Tank Pump (2 no.)
- Stormwater Mixer (2 no.)
- Air Compressor
- Process Air Blowers (4 no.)
- RAS Pump (4 no.)
- Sludge Mixers (3 no.)
- Pasteurisation Feed Pump
- Pasteurisation Tank Mixer (3 no.)
- Pasteurisation Outlet Pump
- Digester Outlet Mixer (2 no.)
- Odour Control Unit Fan (2 no.)
- Final Effluent Washwater Pump
- Liquors Return Pump

From the noise model for the facility, which uses the baseline, or ambient, noise levels, the results show that the predicted noise levels are all below the 45dB(A) night-time criterion typically used by the EPA. Moreover, the noise levels are below background night-time noise levels measured during the survey. It can therefore be expected that while noise from the WWTP may be audible during quiet periods at some locations, it is not expected to be unduly intrusive. Noise monitoring locations are shown in Figures A.5.4 and A.5.5.

## 5.6 Environmental Nuisances

Traffic is the only other possible environmental nuisance created by the site. Traffic on site will be via a one-way system, with trucks and other vehicles entering the site at the northeast corner, and travelling in a clockwise direction around the site.

Traffic to the site, once constructed, is limited to plant personnel and visitors and also traffic associated with the operation of the plant. This includes personnel working at the facility (4 employees maximum at any one time), deliveries of fuel, chemicals or other supplies to the facility, and waste collection vehicles. Sludge bio-cake will be collected a maximum of 4 times per day, when the trailer that accepts the bio-cake is taken off-site, and an empty trailer is left in its place.

The administration building is located to the north of the facility and all visitors are required to park in the parking area adjacent to the building and report to reception.



Traffic is not considered as a significant environmental nuisance and its effect on the surrounding area will be minimal.

## 6.0 MITIGATION MEASURES/ABATMENT

### 6.1 Odour & Air Quality Abatement & Mitigation

The odours generated by the sludge treatment works and the inlet works (and primary settlement tanks) will be monitored to ensure that the maximum allowable odour emission rates are not exceeded.

There are 2 no. Odour Control Units (OCUs) within the facility, one for the sludge treatment works and one for the inlet works (and primary settlement tanks). A flow diagram is provided as Figure A.6.1 to show how the OCUs work within the facility.

The odour control units are designed to extract odour from the specified areas. The odour extraction from these areas will create a negative pressure in these areas so that no odour can escape. In addition, U-traps are provided on all drain points for the OCUs to further ensure that odours will not escape.

The odour model isopleths for the odours generated from the WWTP, following abatement measures, are shown in Figures A.6.2 and A.6.3.

The emissions to atmosphere (excluding odour) are considered to be minor and therefore no abatement systems have been employed on site for the emissions from the boilers (that provide hot water for the pasteurization process) or waste gas burner. Stack monitoring for each boiler stack will be carried out annually by a qualified environmental scientist/consultant.

### F.1(b) Emissions to Surface Waters

As previously discussed, the site is designed so that the majority of surface water runoff from hard stand areas is directed, via gravity, to the designated stormwater drainage system.

No specific treatment systems are employed with respect to the runoff of surface water to the Suir Estuary, however water quality monitoring will be undertaken as required by the Agency.

On-site monitoring of the WWTP will be undertaken on a daily basis. This includes flow readings as well as recording of temperature and pH of both the treated and untreated wastewater. BOD and COD will be monitored on a daily basis using a composite sampler.

Flow readings from the plant will be linked to the data collection system (SCADA) which allows total daily flows and other flow trends to be analysed and recorded, and any malfunctions or problems will be detected and addressed.

Sampling will be undertaken to enable calculation of the quality and quantity of flows discharged to the outfall. Laboratory sampling will be carried out at a nominated laboratory, which will not be on-site.

The samplers that will be used for the final treated effluent (FTE) are automatic and capable of collecting flow proportional composite samples.

The applicant has commenced a water quality monitoring programme for the Suir Estuary at a number of sampling points, which was agreed with the EPA on the 12<sup>th</sup>

October 2007. This water quality monitoring programme includes monitoring at sampling points to show the water quality in areas where the existing outfalls are discharging to.

It is envisaged that this water quality monitoring programme will continue for the initial stages of the operation of the WWTP, i.e. for 2008. It is understood that further information on the monitoring programme will be contained in the wastewater discharge licence application for the new and existing outfalls.

#### **F.1(c) Emissions to Ground**

As previously discussed, there are no direct emissions to ground at the site. The surface water runoff will be directed to swales, from which some water will percolate into the ground.

No specific treatment, abatement or control systems are employed with respect to this process.

#### **F.1(d) Noise Emissions**

Noise abatement measures include fitting the blowers at the aeration tanks with acoustic enclosures, which reduce the noise levels from 100dB(A) at 1m to 70dB(A) at 1m. The remaining plant items generate similar levels of noise to each other. The noise assessment demonstrates that the predicted noise levels are below the EPA criteria for night-time noise and below the existing noise levels at noise-sensitive locations. Taking this into account, no further noise abatement measures are required.

It is proposed that ongoing noise monitoring is carried out annually at the sensitive receptors.

Ongoing management of noise levels will include regular maintenance of equipment to avoid any increase in noise emissions, for example, due to wear or imbalance of rotating parts. Where an item develops a fault which leads to increased noise levels at a boundary or noise-sensitive locations it will be repaired or replaced.

### **7.0 MATERIALS USE & ENERGY EFFICIENCY**

#### **Raw Materials**

The raw materials used will be the fuel for the facility; biogas, electricity and diesel.

Biogas generated within the anaerobic digestors will be stored and used as required to power the boilers (which provide hot water for the pasteurization process). Diesel fuel will be stored on site for the generator and the boilers for situations where there is a shortfall in the primary fuel source, i.e. electricity and biogas.

The capacity of boiler fuel tank is 10,000 litres diesel and the generator fuel tank also holds 10,000 litres diesel.

Polyelectrolytes are used in the thickening and dewatering process of the sewage treatment. These are the only chemicals that will be used on site. Two types are used for the WWTP: PLF 1700Q (for sludge thickening) and PLF 2800Q (for sludge dewatering). The polyelectrolyte will be in powder form and approximately 2.4 tonnes will be held on site, i.e. one week supply.

#### **Products**

The only product from the WWTP will be the sludge bio-cake produced at the final stage of the sludge treatment process. Approximately 38.4 m<sup>3</sup> per day (41.1 tonnes/day) will be produced.

### Energy Requirements

The energy supplied to the WWTP will be from three sources:

- Electricity (from National Grid)
- Biogas from the Anaerobic Digester
- Diesel Fuel

The predicted electricity demand for the everyday operation of the facility is shown in the table below. Electricity demand has been calculated based on the equipment power rating, rather than the predicted absorbed power (or 'Duty' power), i.e. it is based on the absolute maximum power demand at any one time is shown for the plant that will be in operation during everyday operation.

**Table 7.1 Summary of Power Demand for WWTP**

Operational Mode	kW
Equipment Power Rating (Maximum)	1333.1
Absorbed Power Rating (Duty)	730.7
Absorbed Power Rating (Standby)	242.6
Load on Generator (Maximum)	469.9
Absorbed Load on Generator (Duty)	402.3

The 'Standby' column in Table 7.1 shows the power demand of each plant item that would be required should one or more of the 'Duty' plant items be shut down for maintenance or repair, or other reasons.

The 'Load on Generator' power demand is the power that will be required should the electricity supply be temporarily interrupted to the site and the plant has to operate only using the plant absolutely necessary. The plant will be powered from the generator in this case, which is diesel fuelled.

### Energy Efficiency Measures

Energy efficiency measures are outlined in this section.

#### Biogas from Anaerobic Digestors to Fuel Boilers

The boilers (which provide hot water for the pasteurization process) are designed to utilize the biogas (from the anaerobic digestion process) as the primary energy source for this process.

The anaerobic digestion process will produce approximately 2208.3 MJ/hr, which is 0.6 MW. This 0.6 MW is then available to fuel the boilers. Diesel will be a back-up fuel to power the boilers.

#### Secondary Treatment – Use of Blowers in secondary treatment

As part of the secondary treatment, the 5 no. blowers which supply air to the four IBA (Inclined Bubble Aeration) tanks operate on a duty/standby basis. Blowers are only turned on once the dissolved oxygen level within each tank drops below a certain level, thereby conserving energy use.

#### Use of Equipment/Plant

All pumps and plant items for the facility are on duty/standby system, whereby they will only be in operation "as required/on demand". Therefore, the supply is not constant and the energy used by the process is thus minimized.

All plant items were selected based on a number of criteria, one of which was the efficiency of the motor/plant, in order to reduce the energy demand as much as possible.

#### Lighting Efficiencies

The lighting plan for the site was designed in order to reduce the amount of lighted areas required and to reduce the amount of time that artificial lighting is required within the WWTP buildings and across the overall site. Some areas of lighting could not be reduced, either for security reasons, or for health and safety reasons (or both).

## **8.0 ACCIDENT & EMERGENCY PROCEDURES**

The operators of the facility will implement accident and emergency procedures for events that may arise during the course of the operational phase of the WWTP. These are included as part of a Performance Management System (PMS) for the safe and continuous operation of the facility.

These procedures include the following:

1. Emergency Procedure Policy
2. Fire Procedure
3. Flooding Procedure
4. Imminent Severe Weather
5. Power Failure
6. Dealing with Contaminated Influent
7. Dealing with Contaminated Sludge
8. Out of Hours Incident

Prior to commencement of operations of the facility, procedures for the facility will be finalised.

Training will be provided to all personnel in relation to the accident and emergency procedures on site.

These procedures will be reviewed and updated annually.

## **9.0 AFTERCARE, DECOMMISSIONING & RESTORATION**

The WWTP has an expected life-span of approximately 50 years. When the facility reaches end-of-life, WCC (or operators acting on their behalf) will aim to rehabilitate the site, as close as possible to its original condition at the time of commencing operations. The overall objective of this exercise would be to achieve clean closure of the site with no residual liabilities or constraints.

There is no formal Residuals Management Plan currently in place for the site however the following tasks would be implemented as part of any decommissioning activities undertaken:

- All materials used, generated and/or stored on site to be consumed, as much as possible, before closure of the operation. Unused materials to be returned to suppliers where possible. Surplus material to be disposed of in accordance with current legislation and accepted procedures.
- All equipment/machinery to be cleaned and decontaminated in accordance with accepted procedures at time of closure, then removed from site and stored, sold, recycled, reused or otherwise disposed of as appropriate.
- On-site building to be subject to a final maintenance check, and if remaining on-site, to be locked and arrangements made for regular security monitoring to prevent unauthorized entry. If demolition of the existing structures is required, this will be carried out in accordance with accepted practice.
- Environmental audit to be carried out following announcement of closure and prior to actual decommissioning taking place. Purpose of the audit is to identify environmental management requirements during and after decommissioning, including any monitoring required. Requirements of all existing licences/permits at the time of decommissioning to be complied with.
- Costs associated with decommissioning (including remediation, restoration and aftercare) to be identified and appropriate finances made available, prior to any decommissioning works commencing.

## 10.0 STATUTORY REQUIREMENTS & ENVIRONMENTAL CONSIDERATIONS

### Waste Management Acts 1996 & 2003

Section 40(4) of the Waste Management Act 1996 to 2003 states that the Agency shall not grant Waste Licence for an activity unless it is satisfied that certain criteria have been met with regards to:

- (a) Emissions from the facility
- (b) Environmental pollution caused by the operations at the facility

Details of the Waterford WWTP operations and associated activities, emissions and management strategies, along with the abatement and mitigation measures for the operation of the facility, are provided in documentation within various sections of this application.

The Waste Licence, once issued by the EPA, will specify relevant emission limits and performance criteria for the site.

The WWTP operators will review these against existing (and future) data, and where required, a program will be implemented (over and above that already in place) to ensure ongoing compliance. This will include ongoing reference to relevant BAT guidance (where relevant):

Other guidance published by the EC, EPA or other recognized party, specific to individual environmental parameters (e.g.: EPA Guidance Note for Noise in relation to Scheduled Activities) will also be consulted.

### Council Directive 96/61/EC concerning integrated pollution prevention and control

The facility will also comply with the requirements of Council Directive 96/61/EC concerning integrated pollution prevention and control. In particular, the items referred to in Annex IV of the Directive have been taken into consideration and the facility will meet these requirements whilst in operation.

The considerations included in Annex IV area as follows:

1. The use of low-waste technology;
2. The use of less hazardous substances;
3. The furthering of recovery and recycling of substances generated and used in the process, and of waste, where appropriate;
4. Comparable processes, facilities or methods of operation which have been tried with success on an industrial scale;
5. Technological advances and changes in scientific knowledge and understanding;
6. The nature, effects and volume of the emissions concerned;
7. The commissioning dates for new or existing facilities;
8. The length of time needed to introduce the best available technique;
9. The consumption and nature of raw materials (including water) used in the process and their energy efficiency;
10. The need to prevent or reduce to a minimum the overall impact of the emissions on the environment and the risks to it;
11. The need to prevent accidents and to minimize the consequences for the environment.

In terms of low waste technology, the facility has been designed to treat and dewater the waste insofar as possible, thereby reducing the sludge bio-cake to a minimum (at least 23% solids). The facility will generate biogas from the anaerobic digestion process, which will be harnessed and used as an energy source.

The operators of the plant have substantial experience in wastewater treatment and have used processes and methods of operation that will be the most successful at industrial scale and the design of the plant uses the most current technology to achieve the best possible results. Resource use has been considered. This includes assessing the minimum energy required to operate the plant, the minimum amount of materials used in the treatment process and reducing the water use.

All emissions have been examined and appropriate mitigation measures and abatement systems have been included in the overall facility design to reduce the impacts on the environment.

Appropriate accident and emergency procedures will be implemented at the site, in accordance with best practice and relevant legislation.

### **Other Environmental Legislation**

- Air Quality Standards Regulations 2002
- Council Directive relating to limit values for sulphur dioxide, nitrogen dioxide and oxides of nitrogen, particulate matter and lead in ambient air (1999/30/EC)
- Council Directive relating to limit values for benzene and carbon monoxide in ambient air (2000/69/EC)
- European Communities (Waste Water Treatment)(Prevention of Odours and Noise) Regulations 2005 (S.I. No. 787 of 2005)
- Drinking Water Directive (98/83/EC)

- Water Framework Directive (2000/60/EC)
- Bathing Water Directive (71/160/EC)
- Groundwater Directive (2006/60/EC)
- Decision No. 2455/2001/EC – Established list of priority substances in the field of water policy and amending Directive 2000/60/EC
- EC (Drinking Water) Regulations S.I. No. 439 of 2000
- EC (Quality of Water intended for Human Consumption)(Amendment) Regulations S.I. No. 177 of 2000
- Quality of Bathing Waters (Amendment) Regulations S.I. No. 22 of 2001
- EC (Water Policy) Regulations S.I. No. 722 of 2003 (Amended by S.I. No. 413 of 2005)
- EC (Quality of Shellfish Waters) Regulations S.I. No. 268 of 2006
  
- Wildlife Act 1976
- Wildlife (Amendment) Act 2000
- EC Habitats Directive 92/43/EEC
- EC Birds Directive 79/409/EEC
- European Communities (Natural Habitats) Regulations 1997 (amended 2005)
- Shellfish Waters Directive (79/923/EEC)
- Flora Protection Order 1999
- Live Bivalve Molluscs (Production Areas) Designation, 2006

The above legislation has also been considered. Operations at the site are not currently or proposed to have an adverse effect on the aspects of the environment to which they refer.

#### **Fit and Proper Person**

Not Applicable, as the applicant is a Local Authority.

However, the operators of the WWTP will be Celtic Anglian Water (CAW), who will operate the WWTP on behalf of the applicant (WCC) for a prescribed period of time.

The wastewater treatment works that CAW have, or are currently operating, are as follows:

- Ringsend Waste Water Treatment Works (Ireland)
- Clapham Water Treatment Works (UK)
- Grafham Water Treatment Works (UK)
- Pitsford Water Treatment Works (UK)
- Wing Water Treatment Works (UK)

## 11.0 CONCLUSIONS

This non-technical summary includes a brief overview of the waste licence application, detailing each of the sections contained within the waste licence application that are relevant and applicable to the Waterford WWTP.

It should be noted that, in order to obtain a comprehensive and detailed description of the facility and the activities that will be carried out there, the full application should be viewed.

*For inspection purposes only.  
Consent of copyright owner required for any other use.*





Waterford City

Site Location

**Project**  
Waterford WWTP Waste Licence Application

**Reference**  
07/4084A.1.1

**Figure A.1.1**  
O.S. Map showing location of Facility

Grid Reference S6520 1220 Scale 1:50,000

© Ordnance Survey Ireland and Government of Ireland EN0007508



Unit 5, ATS Building, Carrigaline Industrial Park, Carrigaline, Co. Cork  
T: +353 21 438 7400 F: +353 21 483 4617

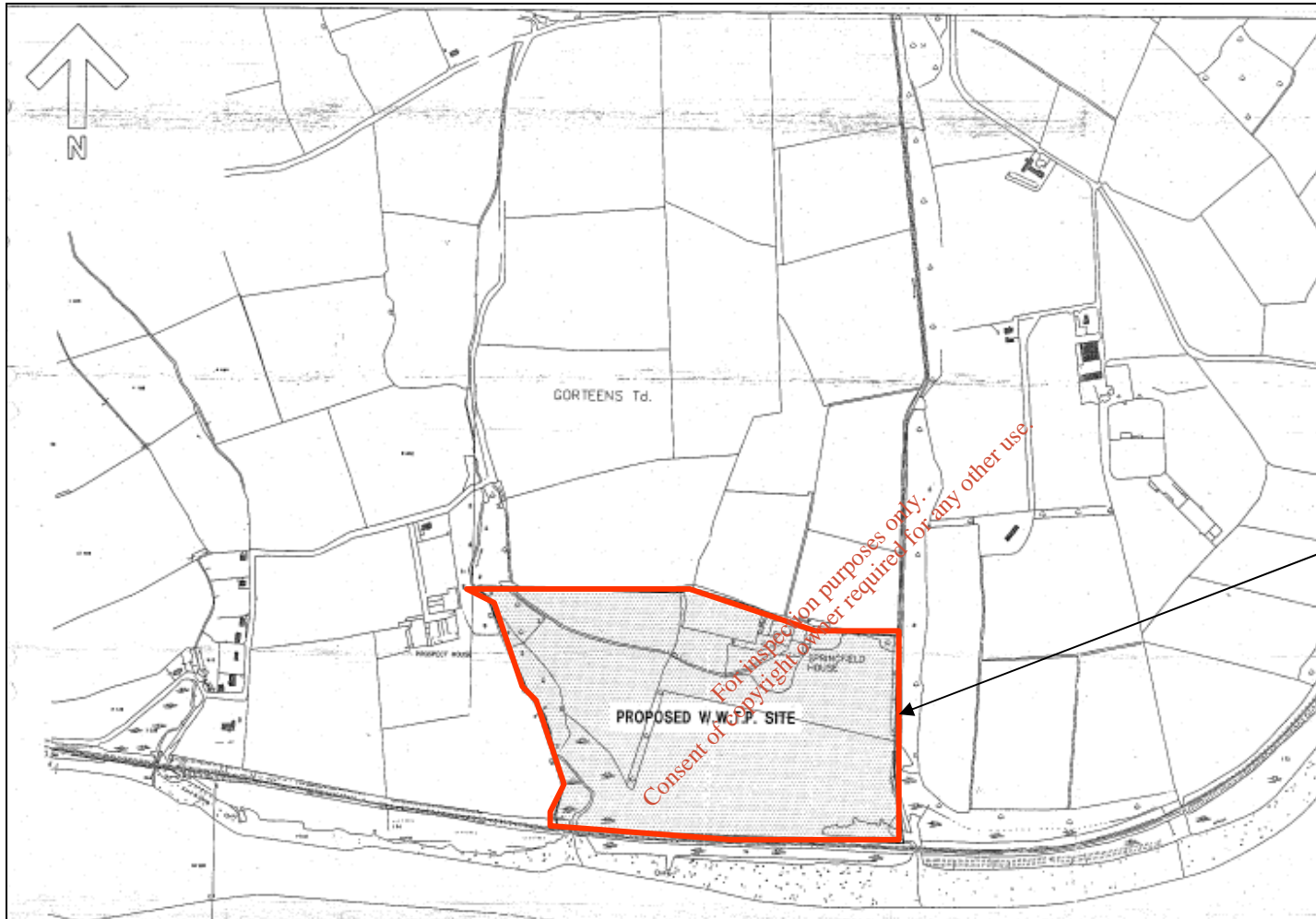

Site Location

<b>Project</b>
Waterford WWTP Waste Licence Application
<b>Reference</b>
07/4084A.1.2

**Figure A.1.2**  
O.S. Map showing location of Facility

Scale 6inch:1 mile (approx. 1:10,560)



Unit 5, ATS Building, Carrigaline Industrial Park, Carrigaline, Co. Cork  
T: +353 21 438 7400 F: +353 21 483 4617

For inspection purposes only.  
Consent of copyright owner required for any other use.

Site Location

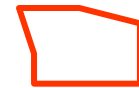

<b>Project</b> Waterford WWTP Waste Licence Application
<b>Reference</b> 07/4084

**Figure B.2 (2)**

© Ordnance Survey Ireland and Government of Ireland EN0007508



Unit 5, ATS Building, Carrigaline Industrial Park, Carrigaline, Co. Cork  
T: +353 21 438 7400 F: +353 21 483 4617

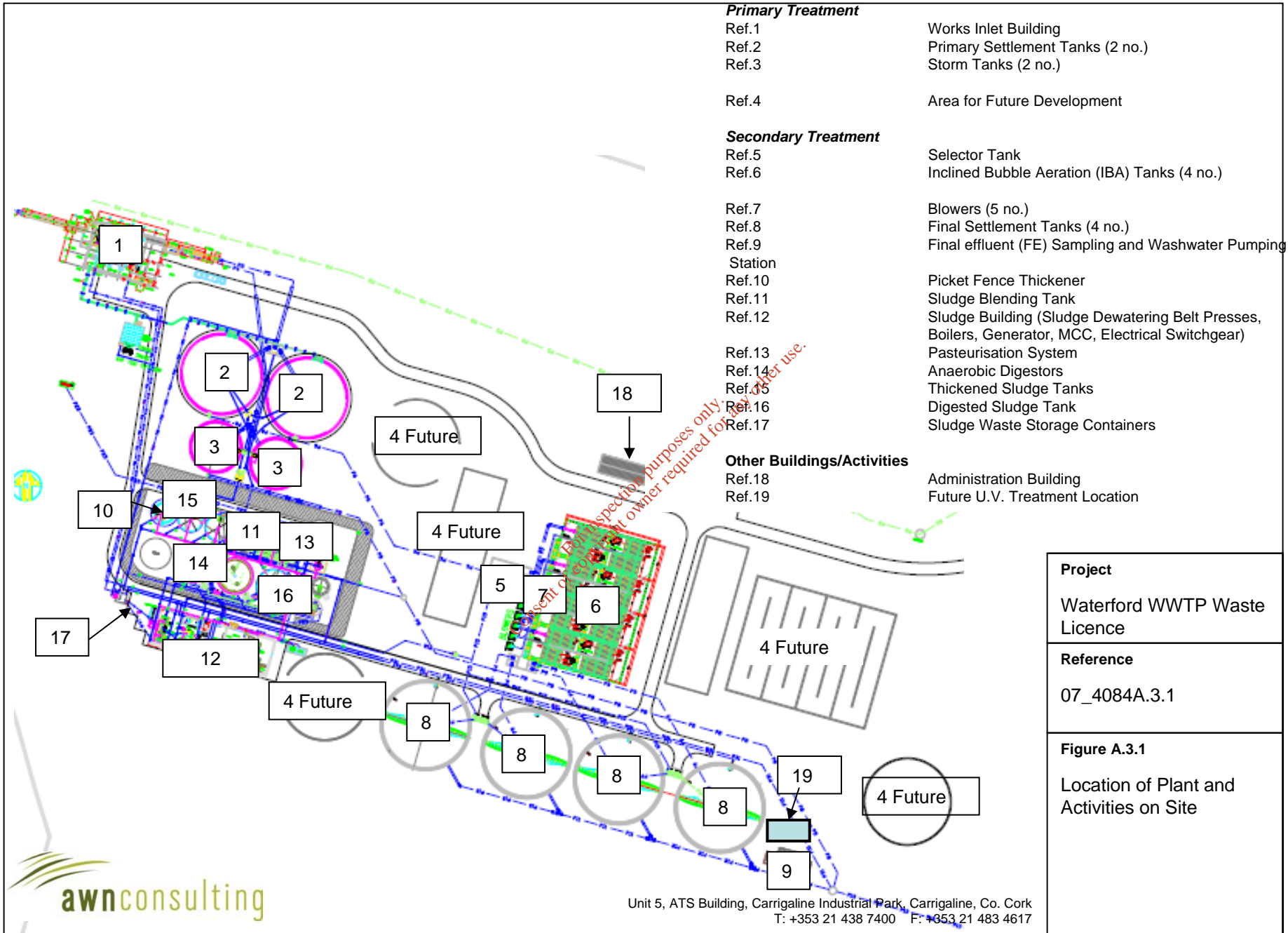

### LEGEND

- PRIMARY DISCHARGE POINT
- SECONDARY DISCHARGE POINT
- STORMWATER OVERFLOW POINT

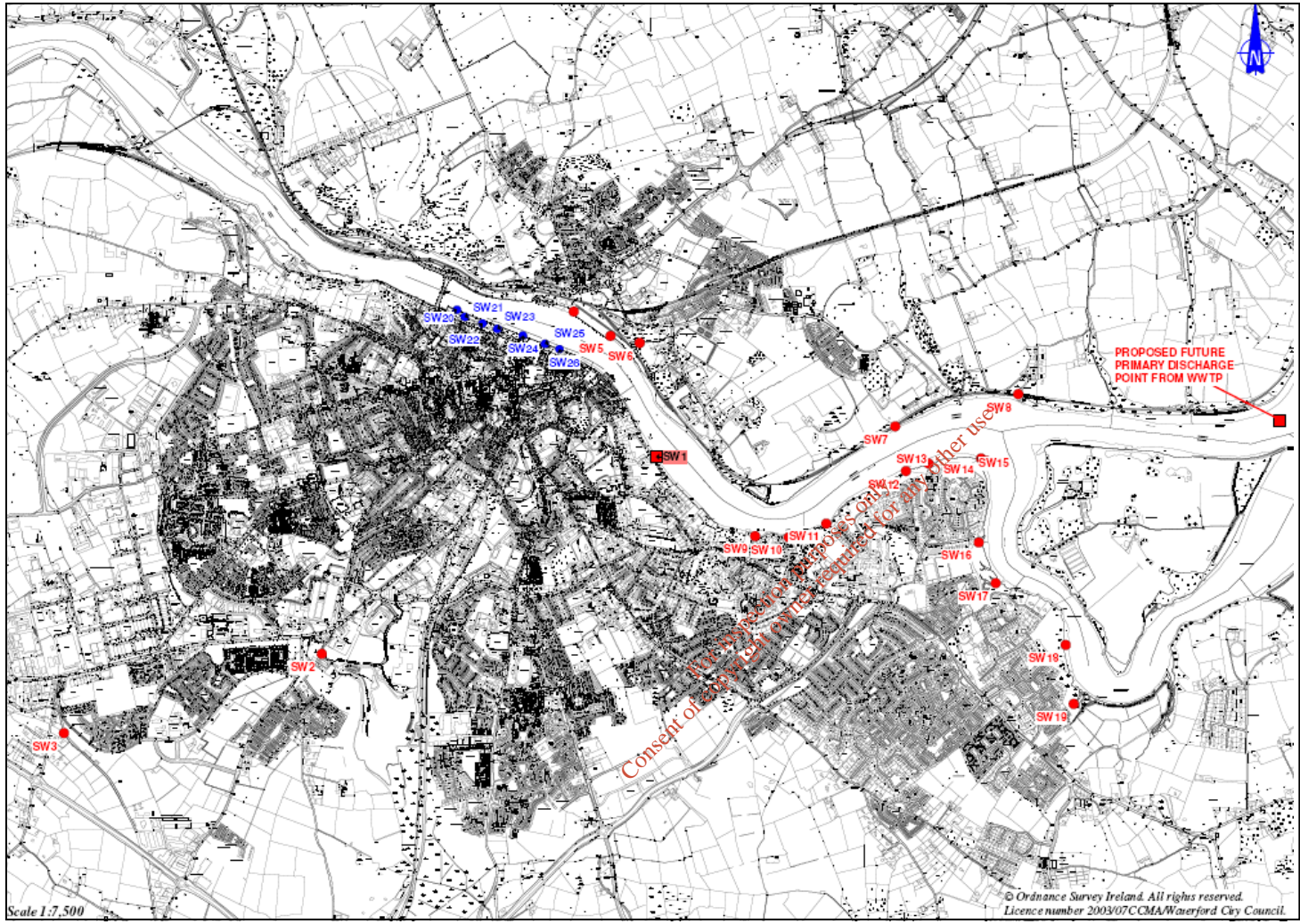

**Project**  
Waterford WWTP Waste Licence Application

**Reference**  
07/4084A.3.2

**Figure A.3.2**  
Location of Existing and New Wastewater Outfalls

Note: Figure taken from Map 11 – Attachment B.4.5 of Mott McDonald Wastewater Discharge Licence Application (Project 241198)



Unit 5, ATS Building, Carrigaline Industrial Park, Carrigaline, Co. Cork  
T: +353 21 438 7400 F: +353 21 483 4617

### LEGEND

- PRIMARY DISCHARGE POINT
- SECONDARY DISCHARGE POINT
- STORMWATER OVERFLOW POINT



**Project**  
Waterford WWTP Waste Licence Application

**Reference**  
07/4084A.3.2

**Figure A.3.2**  
Location of Existing and New Wastewater Outfalls

Note: Figure taken from Map 11 – Attachment B.4.5 of Mott McDonald Wastewater Discharge Licence Application (Project 241198)



Unit 5, ATS Building, Carrigaline Industrial Park, Carrigaline, Co. Cork  
T: +353 21 438 7400 F: +353 21 483 4617

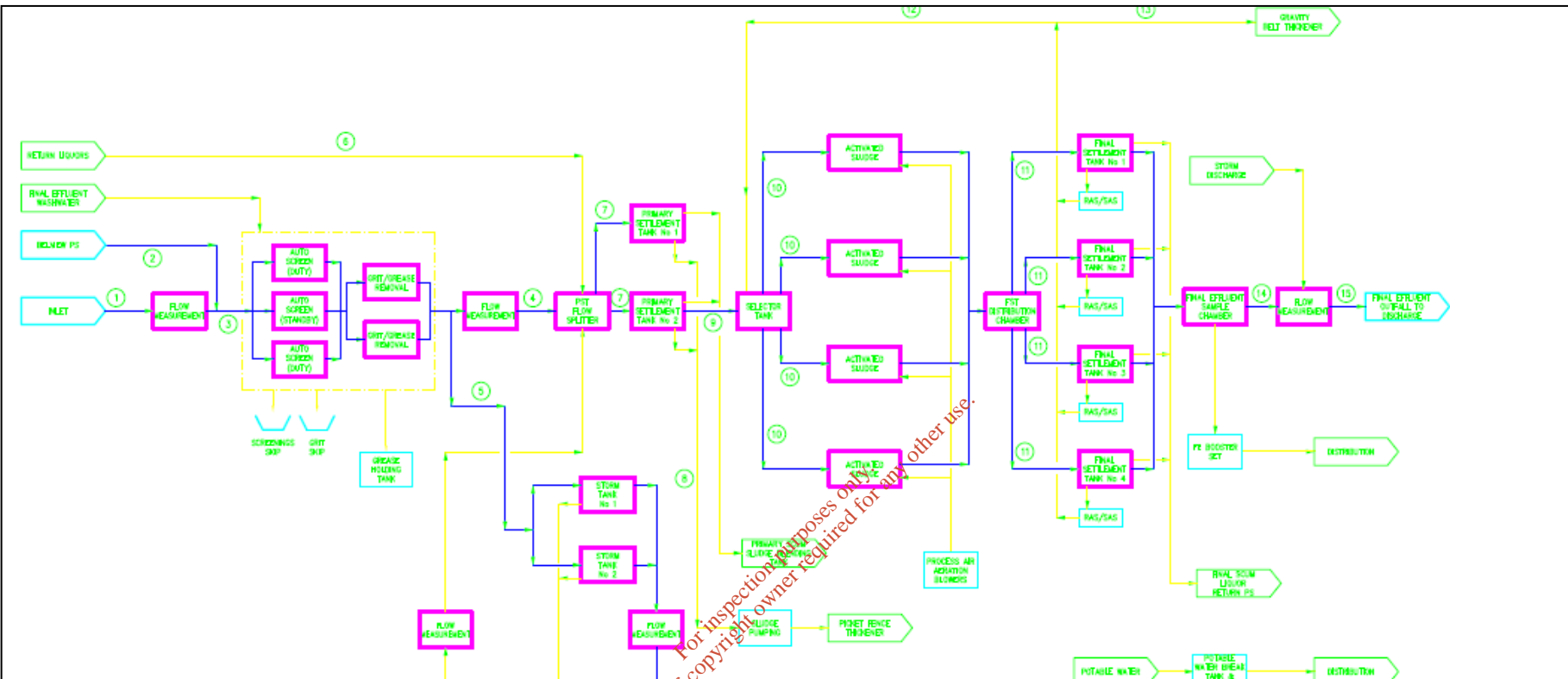

For inspection purposes only. Consent of copyright owner required for any other use.

<b>Project</b>
Waterford WWTP Waste Licence Application
<b>Reference</b>
07_4084A.3.3
<b>Figure A.3.3</b>
Overall Flow Diagram of the WWTP



Unit 5, ATS Building, Carrigaline Industrial Park, Carrigaline, Co. Cork  
 T: +353 21 438 7400 F: +353 21 483 4617

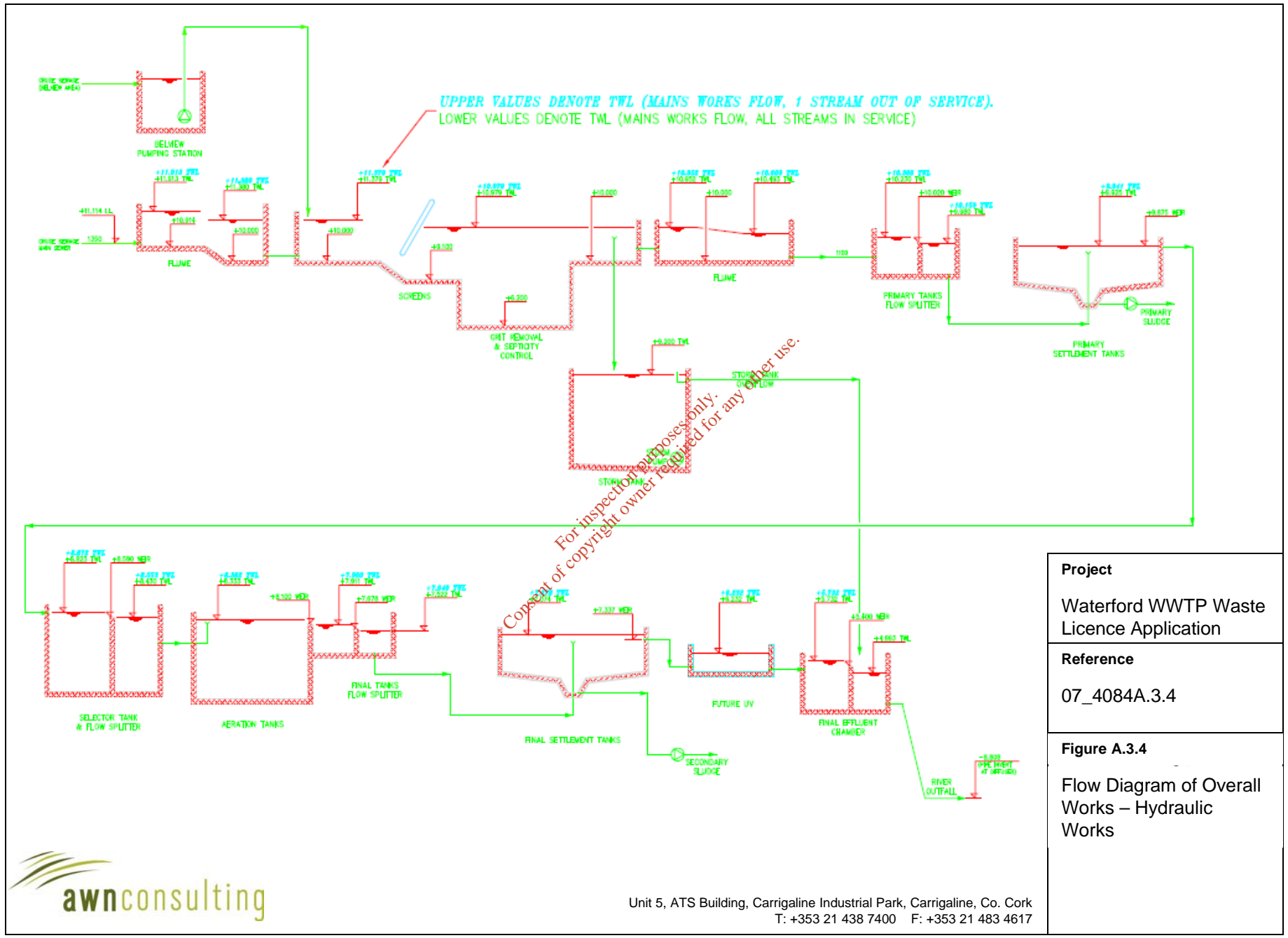

<b>Project</b>	Waterford WWTP Waste Licence Application
<b>Reference</b>	07_4084A.3.4

**Figure A.3.4**  
 Flow Diagram of Overall Works – Hydraulic Works



Unit 5, ATS Building, Carrigaline Industrial Park, Carrigaline, Co. Cork  
 T: +353 21 438 7400 F: +353 21 483 4617



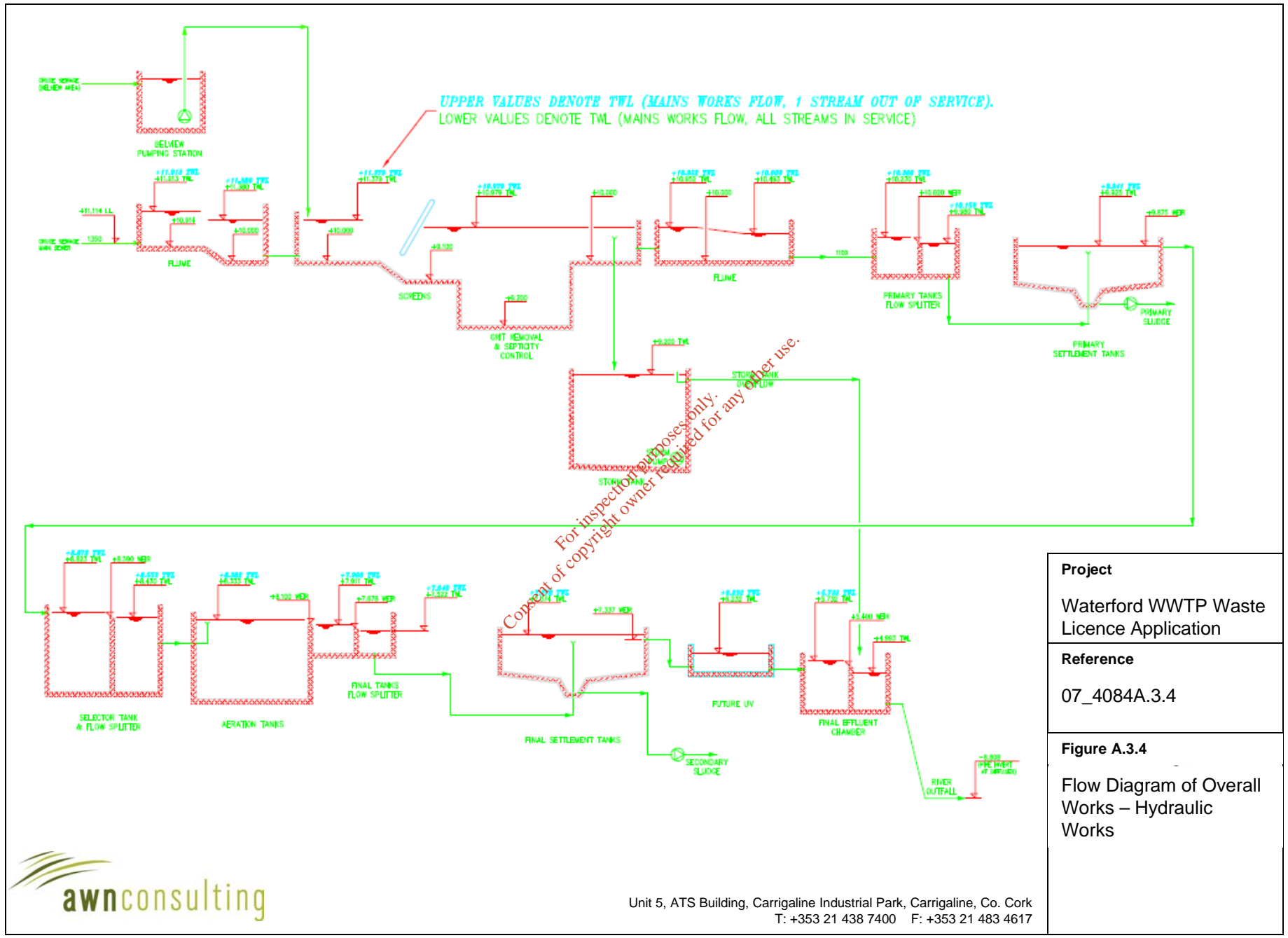

<b>Project</b>	Waterford WWTP Waste Licence Application
<b>Reference</b>	07_4084A.3.4

**Figure A.3.4**  
 Flow Diagram of Overall Works – Hydraulic Works



Unit 5, ATS Building, Carrigaline Industrial Park, Carrigaline, Co. Cork  
 T: +353 21 438 7400 F: +353 21 483 4617

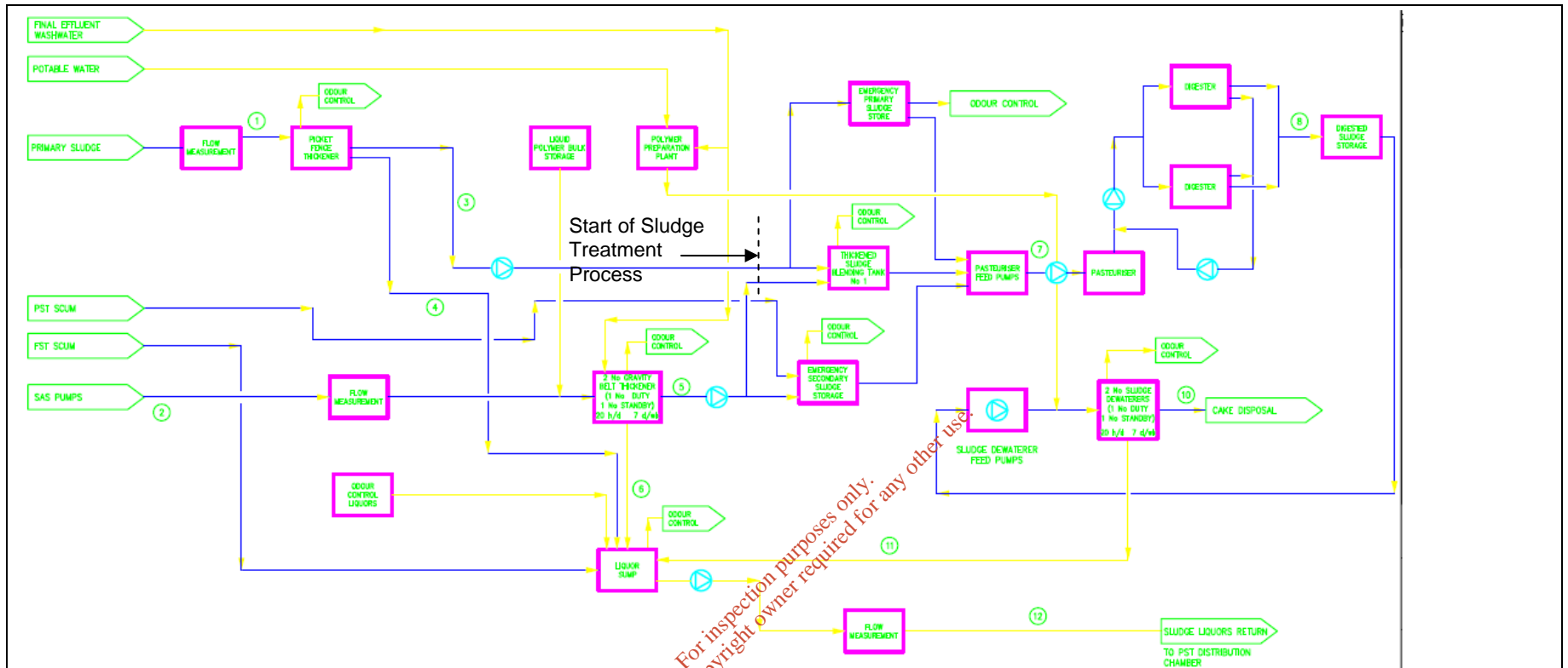

For inspection purposes only.  
Consent of copyright owner required for any other use.

<b>Project</b>	Waterford WWTP Waste Licence Application
<b>Reference</b>	07/4084A.3.5
<b>Figure A.3.5</b>	Flow Diagram of Sludge Works



Unit 5, ATS Building, Carrigaline Industrial Park, Carrigaline, Co. Cork  
T: +353 21 438 7400 F: +353 21 483 4617

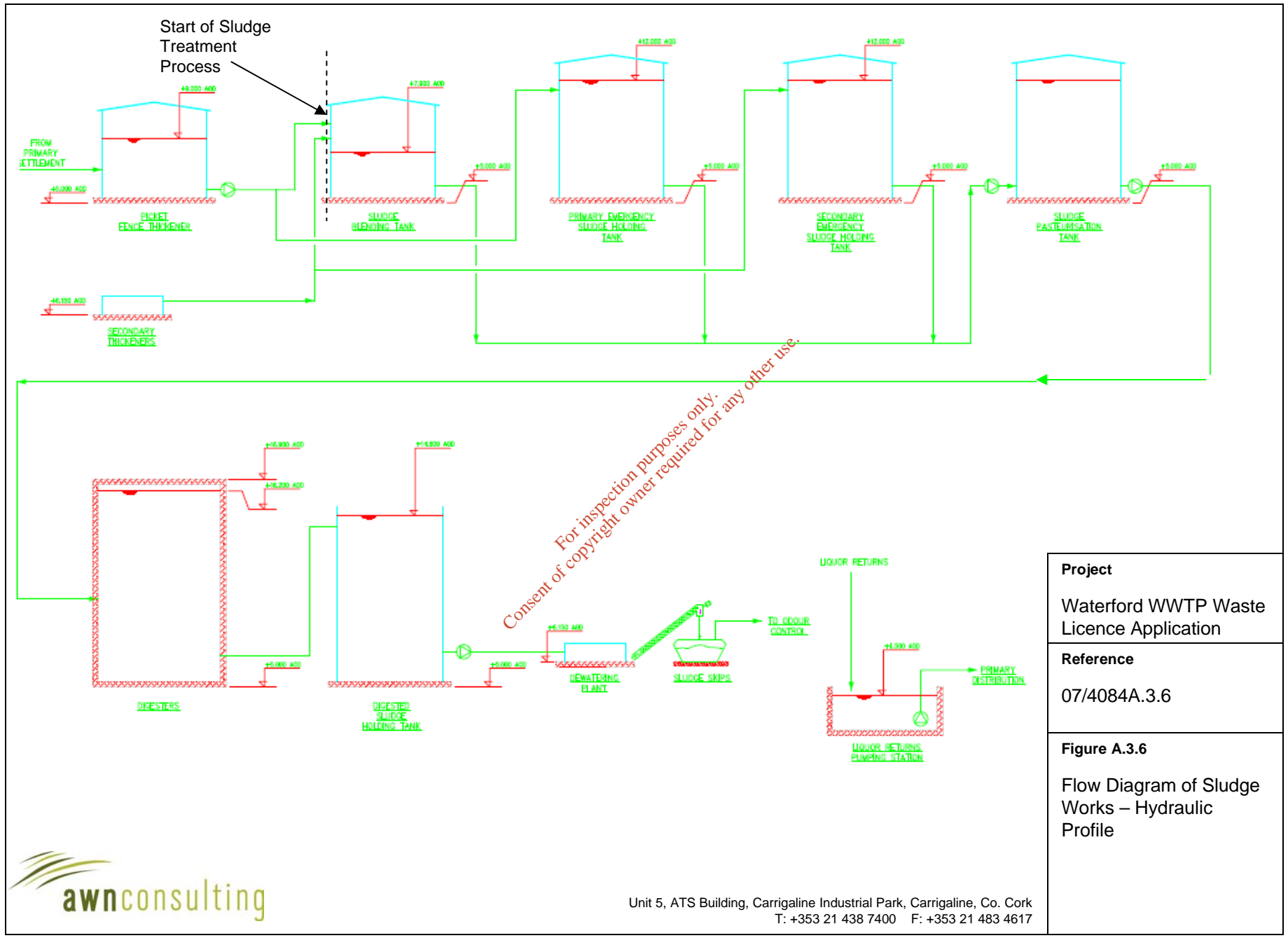

<b>Project</b>	Waterford WWTP Waste Licence Application
<b>Reference</b>	07/4084A.3.6

**Figure A.3.6**  
Flow Diagram of Sludge Works – Hydraulic Profile



Unit 5, ATS Building, Carrigaline Industrial Park, Carrigaline, Co. Cork  
T: +353 21 438 7400 F: +353 21 483 4617

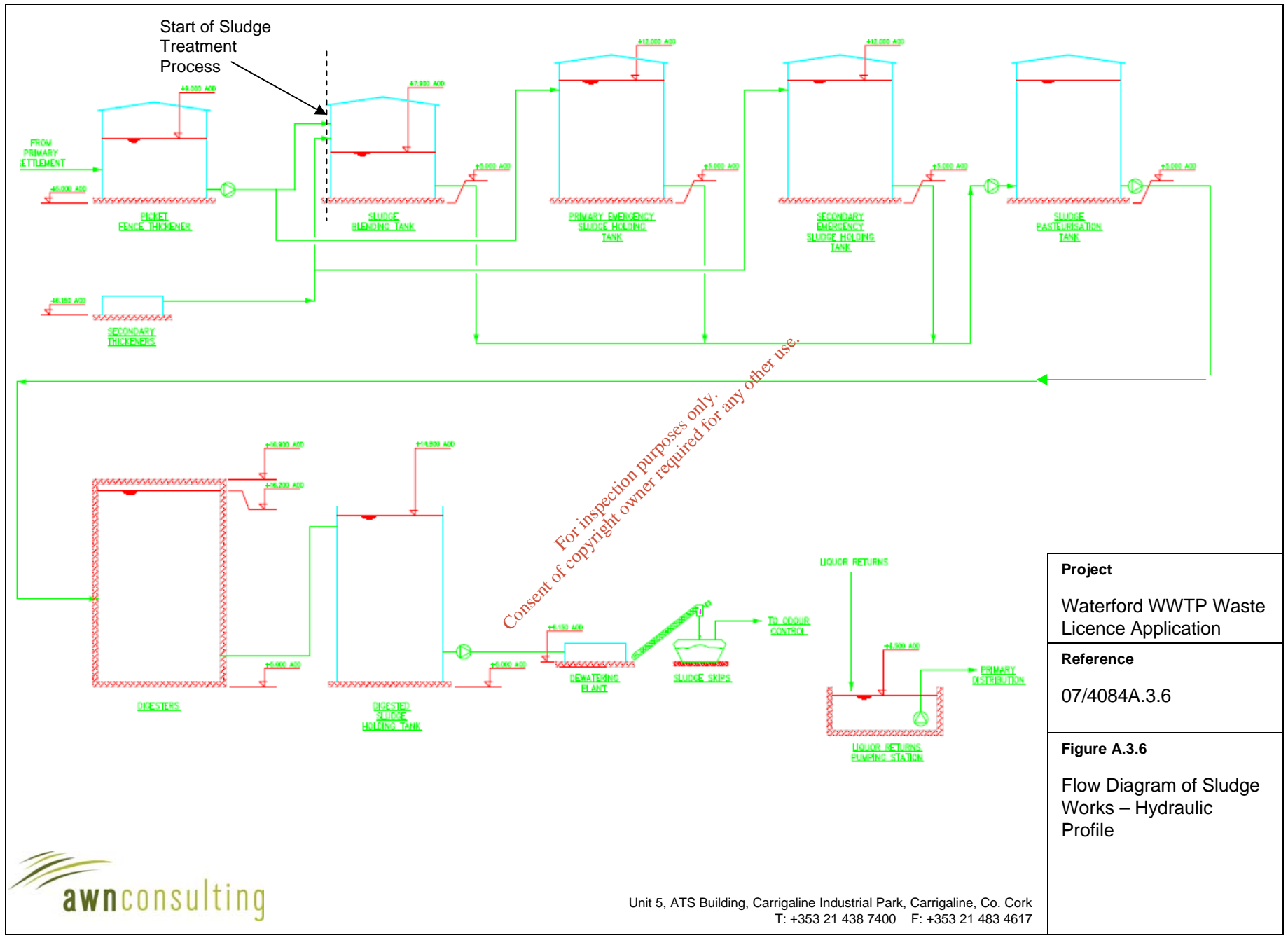

<b>Project</b>	Waterford WWTP Waste Licence Application
<b>Reference</b>	07/4084A.3.6

**Figure A.3.6**  
Flow Diagram of Sludge Works – Hydraulic Profile



Unit 5, ATS Building, Carrigaline Industrial Park, Carrigaline, Co. Cork  
T: +353 21 438 7400 F: +353 21 483 4617

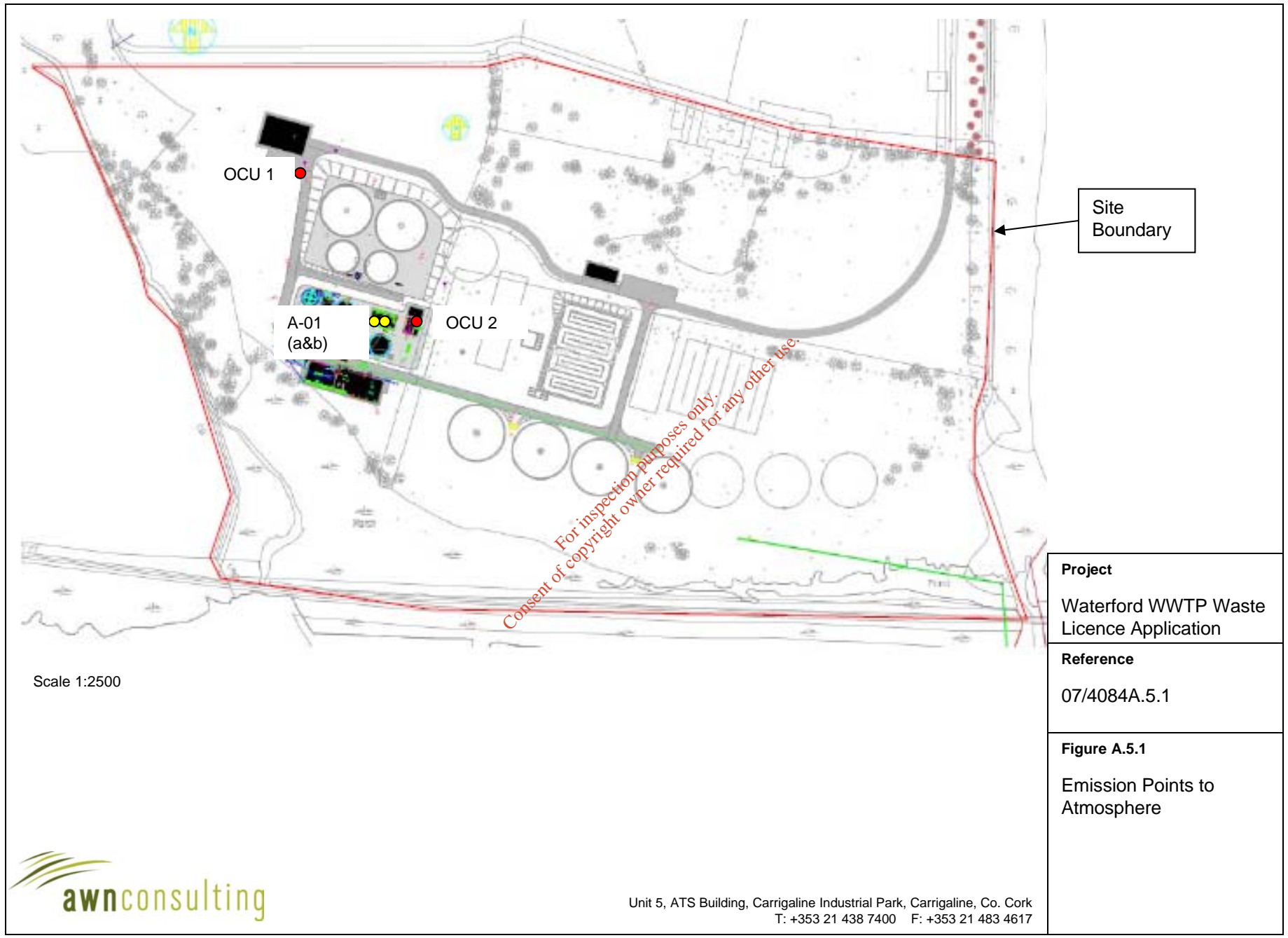

Site Boundary

OCU 1

A-01 (a&b)

OCU 2

For inspection purposes only.  
 Consent of copyright owner required for any other use.

<b>Project</b>	Waterford WWTP Waste Licence Application
<b>Reference</b>	07/4084A.5.1

**Figure A.5.1**  
 Emission Points to Atmosphere

Scale 1:2500



Unit 5, ATS Building, Carrigaline Industrial Park, Carrigaline, Co. Cork  
 T: +353 21 438 7400 F: +353 21 483 4617

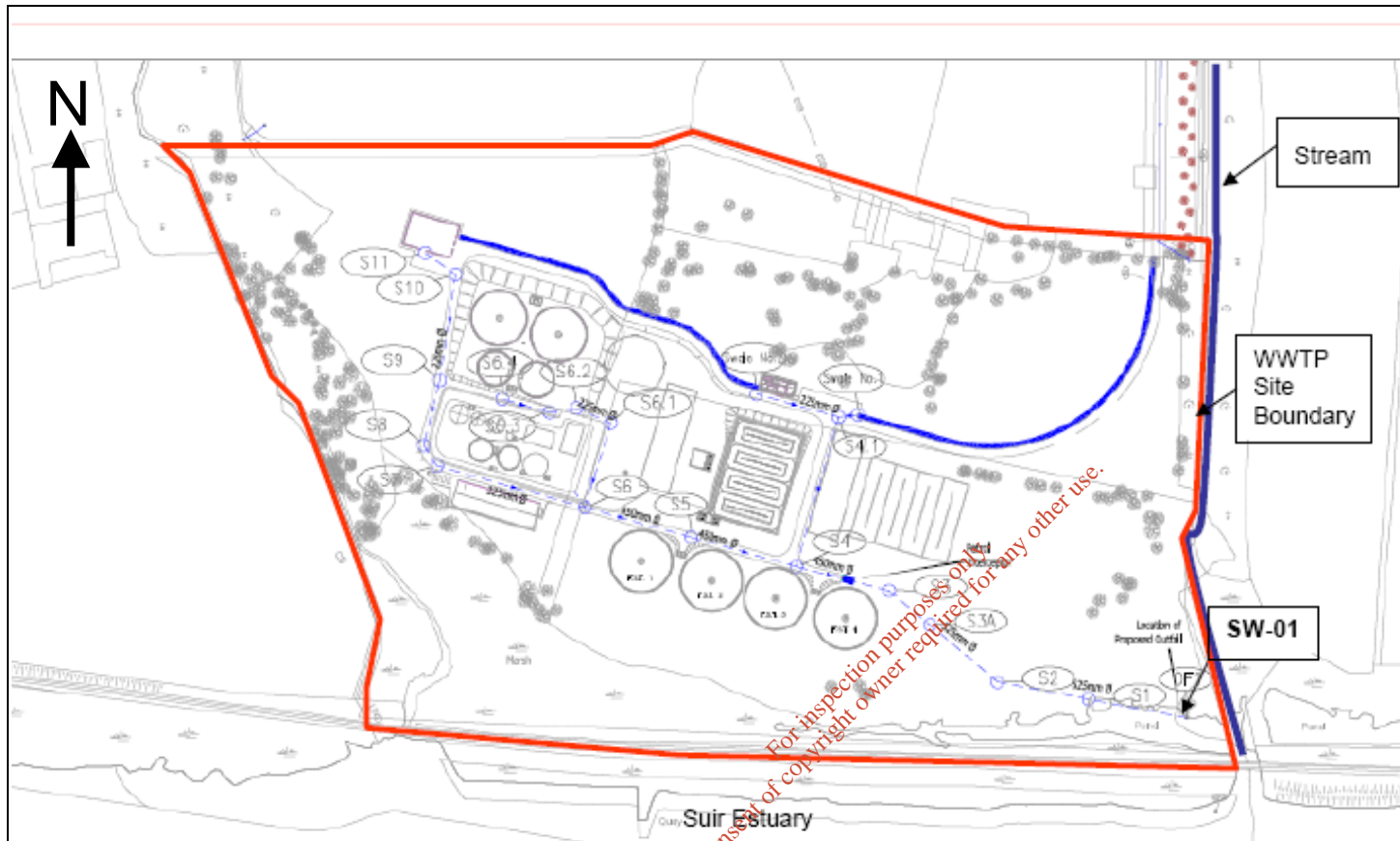

<b>Project</b>	Waterford WWTP Waste Licence Application
<b>Reference</b>	07/4084A.5.2
<b>Figure A.5.2</b>	Location of Emission Point SW-01



Unit 5, ATS Building, Carrigaline Industrial Park, Carrigaline, Co. Cork  
 T: +353 21 438 7400 F: +353 21 483 4617

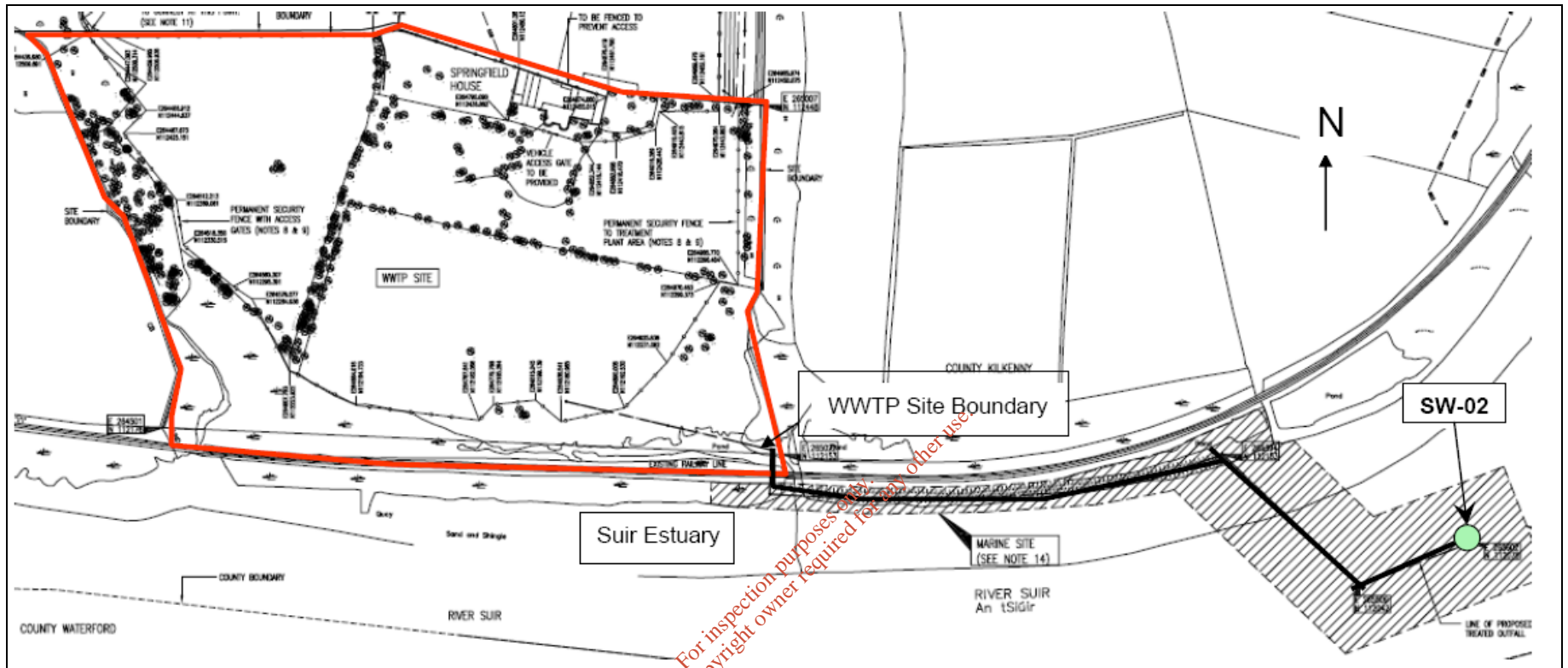

Scale 1:5000

For inspection purposes only. Consent of copyright owner required for any other use.

<b>Project</b>
Waterford WWTP Waste Licence Application
<b>Reference</b>
07/4084A.5.3
<b>Figure A.5.3</b>
Location of Emission Point SW-02



Unit 5, ATS Building, Carrigaline Industrial Park, Carrigaline, Co. Cork  
 T: +353 21 438 7400 F: +353 21 483 4617

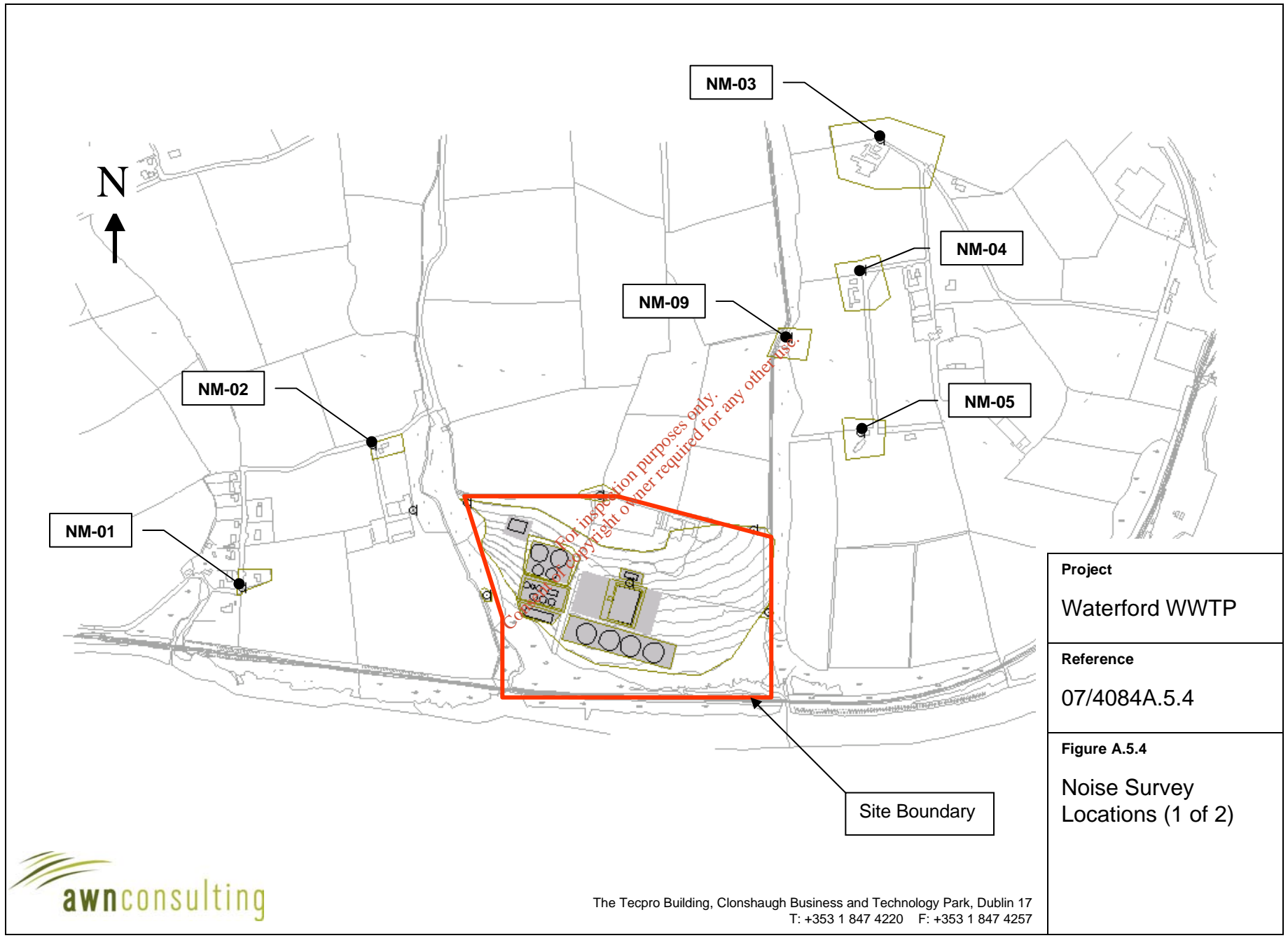

<b>Project</b>	Waterford WWTP
<b>Reference</b>	07/4084A.5.4
<b>Figure A.5.4</b>	Noise Survey Locations (1 of 2)



The Tecpro Building, Clonshaugh Business and Technology Park, Dublin 17  
 T: +353 1 847 4220 F: +353 1 847 4257



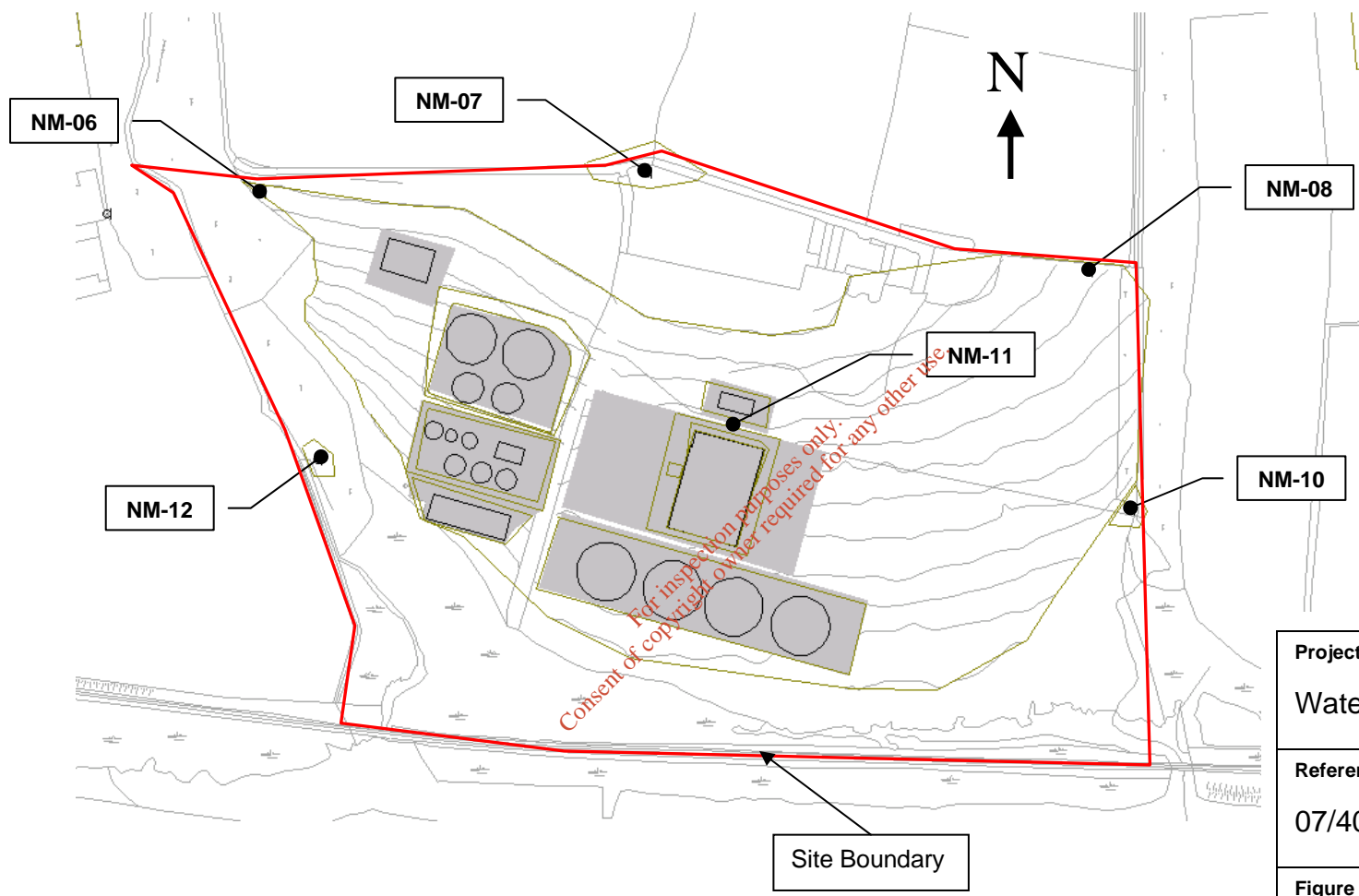

<b>Project</b>	Waterford WWTP
<b>Reference</b>	07/4084A.5.5
<b>Figure A.5.5</b>	Noise Survey Locations (2 of 2)



The Tecpro Building, Clonshaugh Business and Technology Park, Dublin 17  
 T: +353 1 847 4220 F: +353 1 847 4257

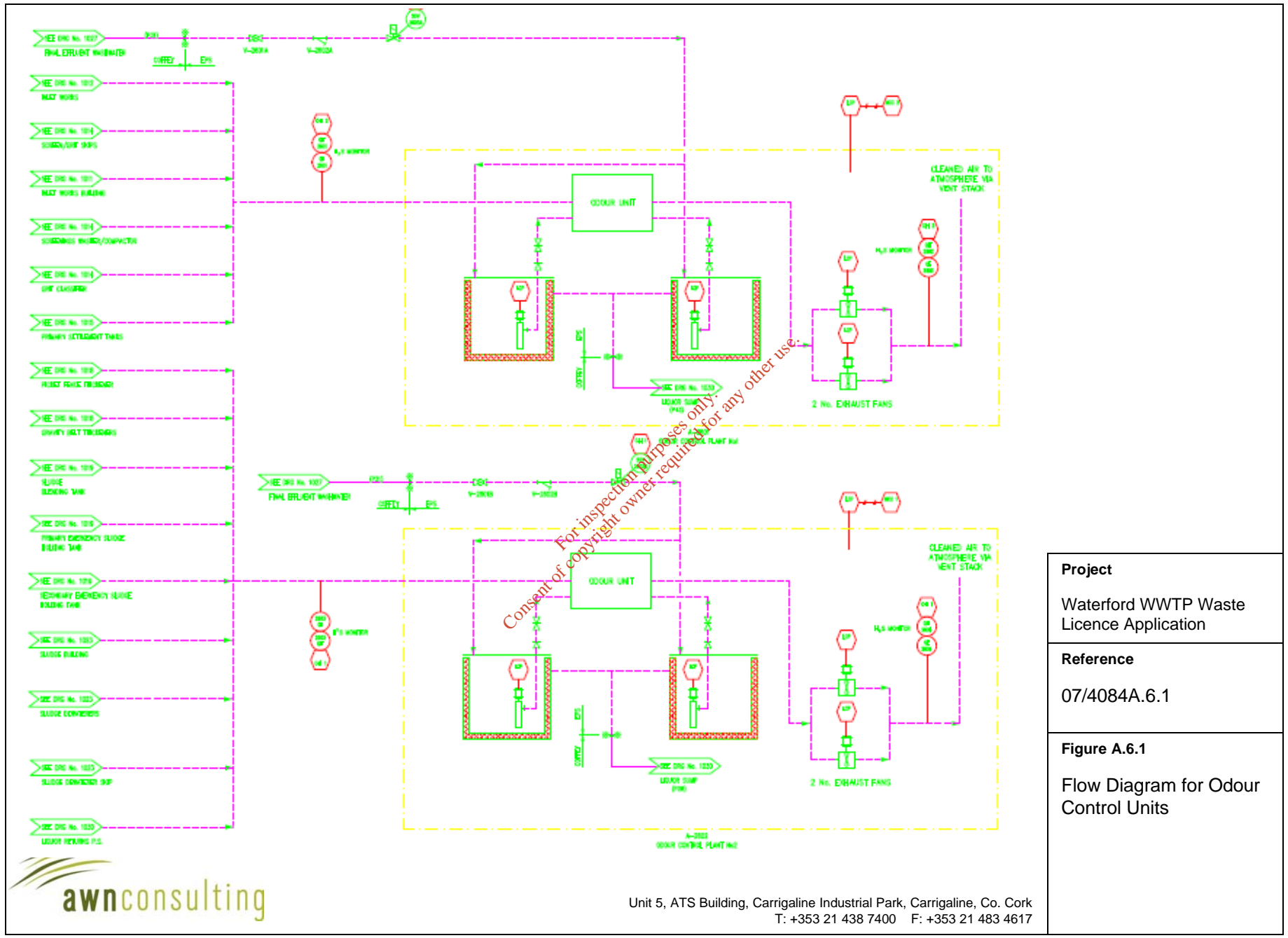

<b>Project</b>
Waterford WWTP Waste Licence Application
<b>Reference</b>
07/4084A.6.1

**Figure A.6.1**  
Flow Diagram for Odour Control Units



Unit 5, ATS Building, Carrigaline Industrial Park, Carrigaline, Co. Cork  
T: +353 21 438 7400 F: +353 21 483 4617

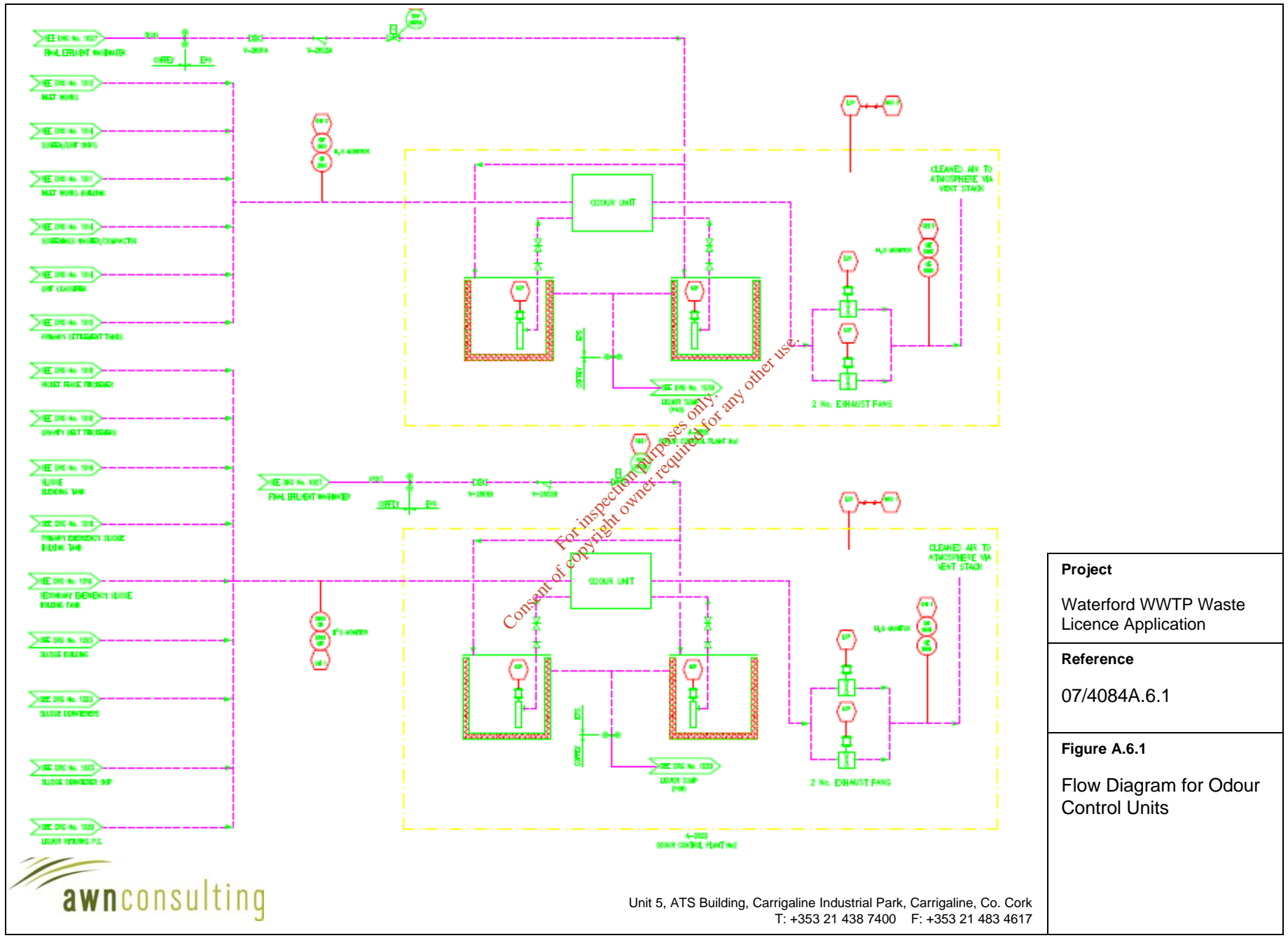

<b>Project</b>
Waterford WWTP Waste Licence Application
<b>Reference</b>
07/4084A.6.1

**Figure A.6.1**  
Flow Diagram for Odour Control Units



Unit 5, ATS Building, Carrigaline Industrial Park, Carrigaline, Co. Cork  
T: +353 21 438 7400 F: +353 21 483 4617

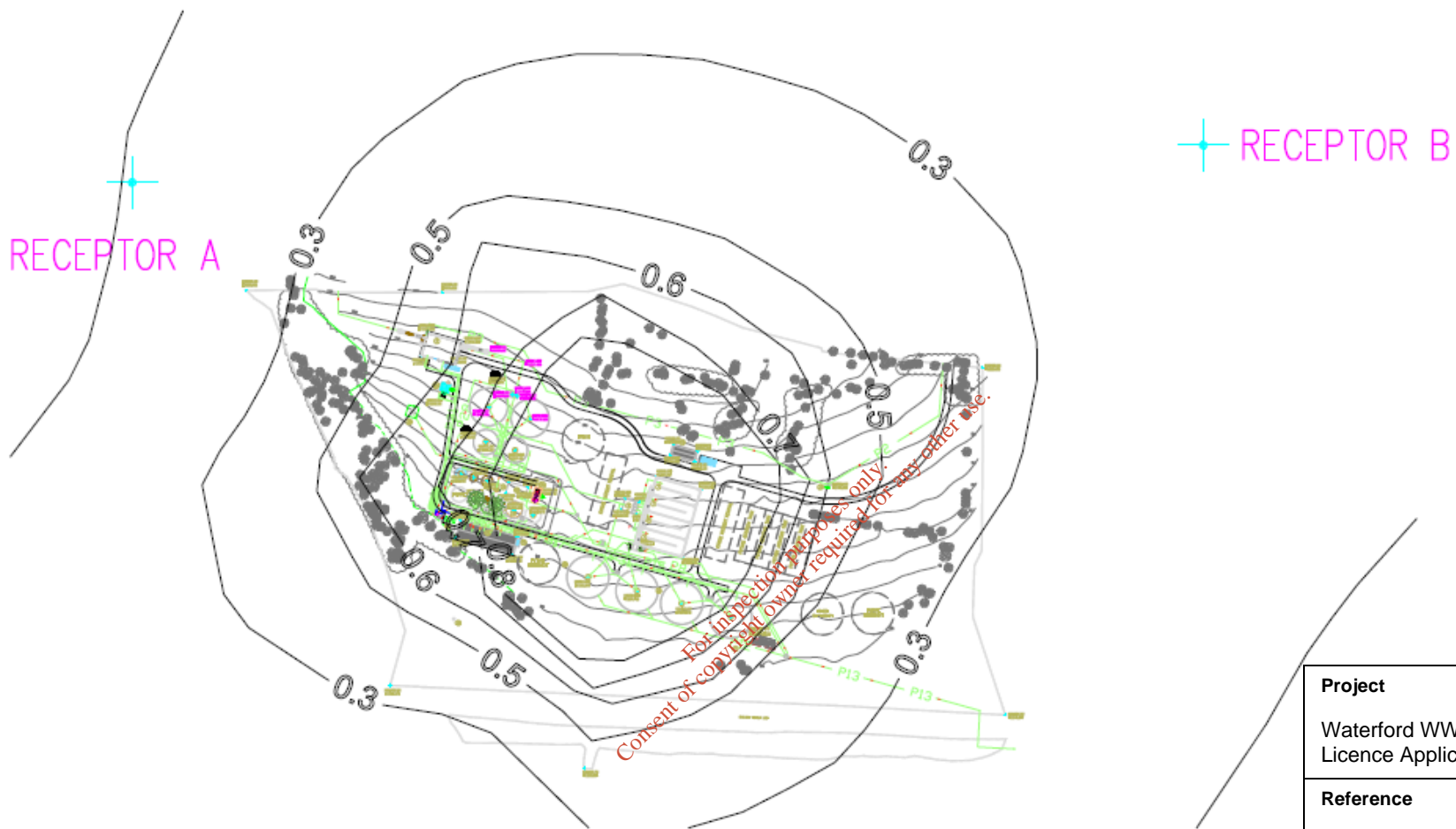

<b>Project</b>
Waterford WWTP Waste Licence Application
<b>Reference</b>
07/4084A.6.2

**Figure A.6.2**  
 Odour Model Isoleth – Predict Odour Concentrations in ouE/m3 (95%ile)

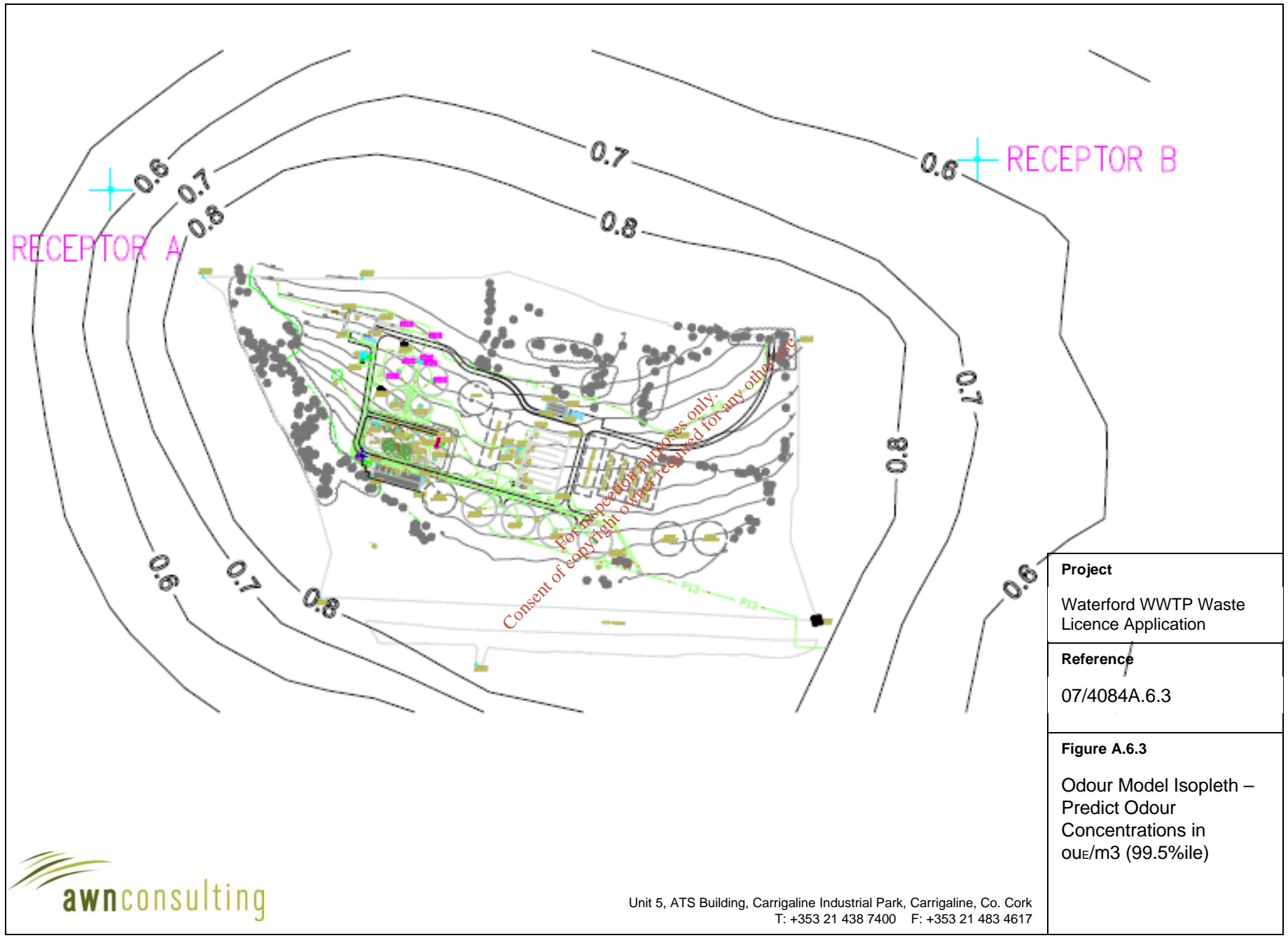

<b>Project</b>
Waterford WWTP Waste Licence Application
<b>Reference</b>
07/4084A.6.3

**Figure A.6.3**  
 Odour Model Isoleth – Predict Odour Concentrations in oue/m3 (99.5%ile)



Unit 5, ATS Building, Carrigaline Industrial Park, Carrigaline, Co. Cork  
 T: +353 21 438 7400 F: +353 21 483 4617